

Setup Guide

TEC Controller

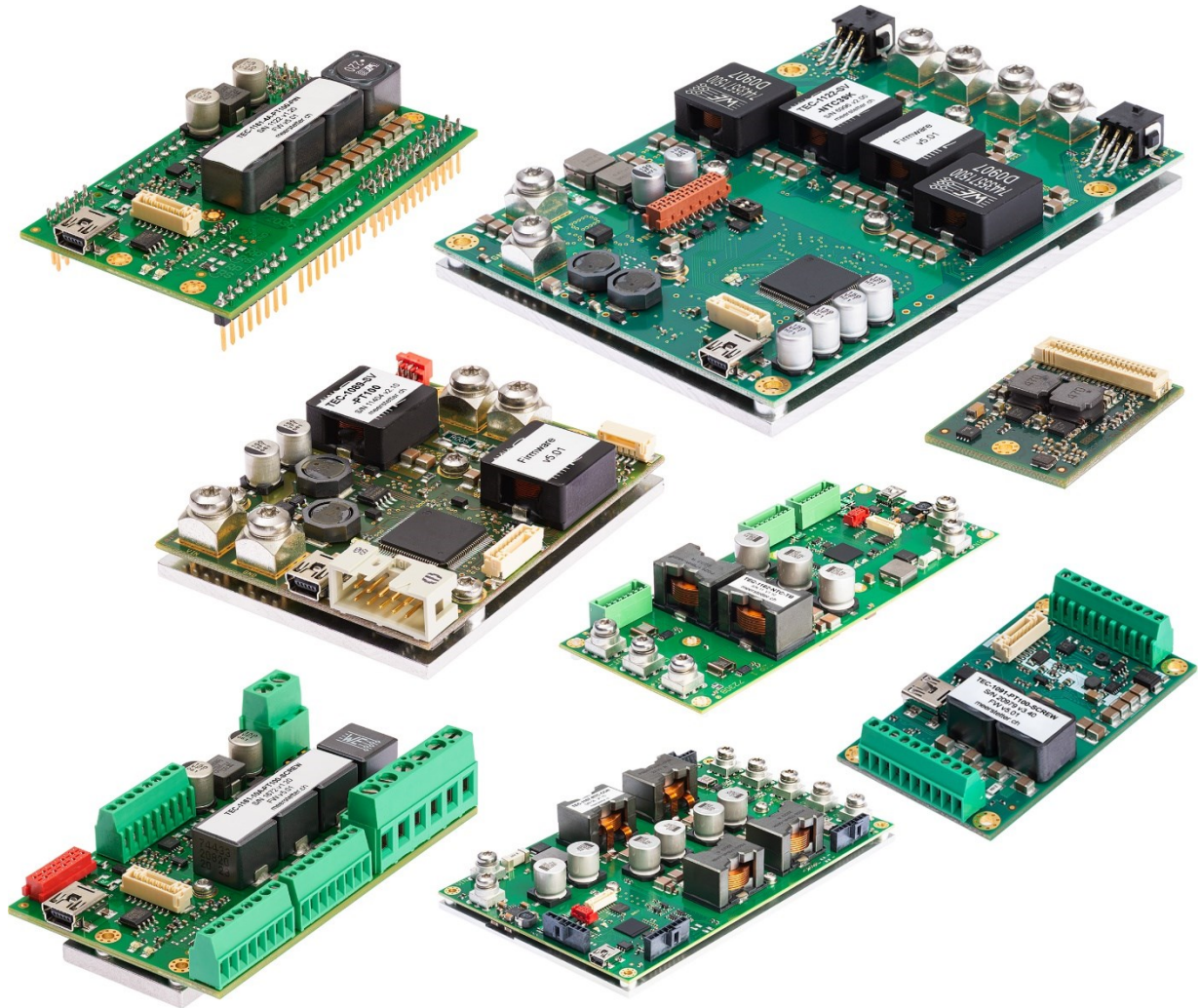

TEC-Family

TEC-1092

TEC-1091

TEC-1089

TEC-1090

TEC-1122

TEC-1123

TEC-1161

TEC-1162

TEC-1163

TEC-1166

TEC-1167

meerstetter
engineering 

 Member of Berndorf Group



Developed, assembled and tested in Switzerland

Index

- 1 Introduction 4
- 2 Material & Prerequisites 5
- 3 Mechanical Setup..... 5
- 4 PC Software Installation..... 6
 - 4.1 TEC Configuration Software Installation 6
- 5 Hardware Setup 7
 - 5.1 Connect the High Resolution Input Sensor 7
 - 5.2 Connect the Peltier Element 7
 - 5.3 Connect the Power Supply..... 7
- 6 Software Setup..... 10
 - 6.1 Default Configuration..... 10
 - 6.2 Temperature Measurement 10
 - 6.3 Peltier Element Characteristics 11
 - 6.4 Temperature Controller 11
 - 6.5 Auto Tuning..... 14
- 7 Further Information 16
- A Change History 17

Meerstetter Engineering GmbH

Schulhausgasse 12

CH-3113 Rubigen

Switzerland

Phone: +41 31 529 21 00

Email: contact@meerstetter.ch

Meerstetter Engineering GmbH (ME) reserves the right to make changes without further notice to the product described herein. Information furnished by ME is believed to be accurate and reliable. However typical parameters can vary depending on the application and actual performance may vary over time. All operating parameters must be validated by the customer under actual application conditions.

Document 5182N

Release date: 16 September 2024

1 Introduction

This step-by-step guide will help you setting up a Meerstetter Engineering TEC Controller for the first time. The goal is to avoid difficulties, save time at first use, and get familiar with the TEC Configuration Software.

As an example, we set up a thermoelectric cooling system to keep an object at a constant temperature. This means that the TEC Controller will supply a Peltier element, to heat and cool depending on the measured temperature of the object.

The following topics will be treated in this guide:

1. Software installation
2. Hardware setup
3. Default configuration
4. Temperature measurement
5. Peltier element characteristics
6. Temperature controller
7. PID controller auto tuning

The following symbols are used to categorize the steps of the guide:

- ✕ Actions to be performed by the user.
- 🔍 Reactions from the soft- or hardware, as indication that an action was successful.
- 📘 Additional background information to the step to be performed.

2 Material & Prerequisites

The following components were used for this example:

- TEC-1089-SV-NTC Controller
- CAB-6154 for TEC-1089
- Peltier element (CUI Inc. CP40236)
- Heatsink
- PC with Microsoft Windows 10
- Cable with Mini-USB-B connector
- Object temperature sensor (NTC 10K, B value = 3988K)
- Heatsink temperature sensor: None (a fixed temperature value is used)
- Power supply (24V, 6A output)
- Soldering station

This is a general TEC Controller setup guide, so you can follow the steps even if you don't use the same materials and controller for your setup.

Please adapt the instructions to your TEC Controller, especially in chapter 5.

3 Mechanical Setup

This is an overview of the cooling system. The TEC Controller is configured and monitored by the TEC Configuration Software on the PC. The temperature sensor and the Peltier element are connected to the TEC Controller. The Peltier element is placed on the heat sink with the cold side (marked side) facing upwards. The connections are described later, step by step.

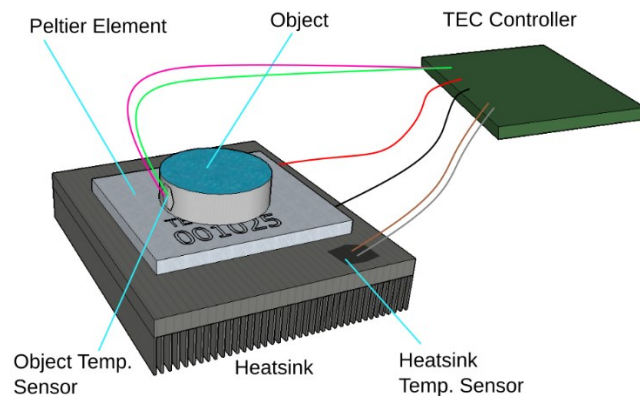
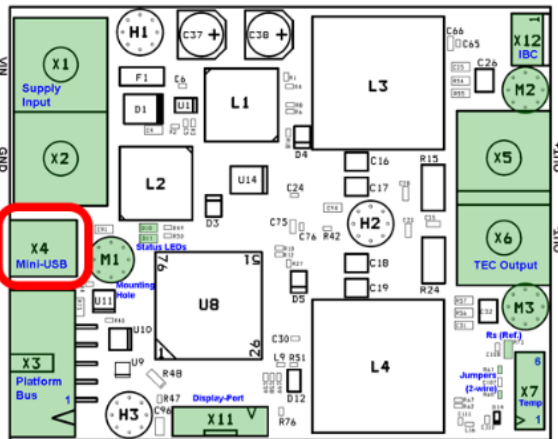

Figure 1. Typical setup of the thermoelectric cooling system, please note that in our example setup we are not using a heatsink temperature sensor.

4 PC Software Installation

4.1 TEC Configuration Software Installation

- ✗ [Download the TEC-Family TEC Controllers Software Package \(.msi\).](#)
- ✗ Execute the MSI-file and follow the instructions to install the application.
- ① The MSI setup procedure will also provide you the USB driver (FTDI) if you do not have the necessary versions already installed.
- 🔍 Two new icons appear on your desktop: "TEC Configuration Software vX.YZ" and "TEC Software vX.YZ Additional" with further information's.
- 🔍 The "Additional" folder also contains the firmware upgrade file for the TEC Controller itself and some other helpful stuff.
- ✗ Connect the TEC Controller on X4 to your PC using a Mini-USB-B cable.



- ✗ Open the TEC Configuration Software (TEC Configuration vX.YZ).
- ✗ Get familiar with the various windows of the TEC Configuration Software and their names.
- 🔍 The TEC Configuration Software displays: "Scanning USB..." in the status bar at the bottom because the TEC Controller is not yet powered by the external power supply.

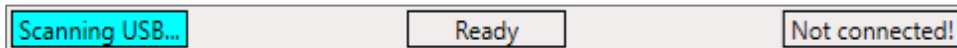

5 Hardware Setup

In this tutorial we use a TEC-1089, the given specifications are not valid for all TEC Controllers. Please check the specifications with the information in the corresponding data sheet of your device.

5.1 Connect the High Resolution Input Sensor

- ✗ Consult the pinout in the [CAB-6154 specifications \(PDF\)](#) to learn how to connect the High Resolution (HR) Input temperature sensor.
- ✗ Solder the NTC temperature sensor to the pre-assembled cable (grey and yellow wires of CAB-6154).

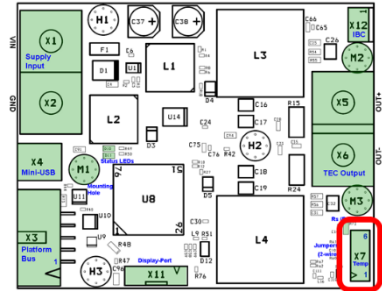
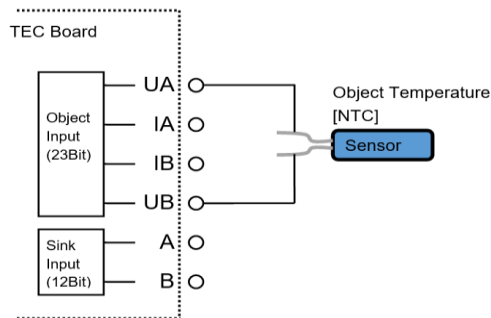

- ✗ Connect the sensor to the X7 connector of the TEC Controller.
- ⓘ A sink temperature sensor is not used in our case (pins 1 and 2 of X7 or white and brown wires of CAB-6154).

5.2 Connect the Peltier Element

- ✗ Connect the red cable of the Peltier element to X5 (OUT+).
- ✗ Connect the black cable of the Peltier element to X6 (OUT-).
- ⓘ The cold side of the Peltier element will be the one with the identification marking.

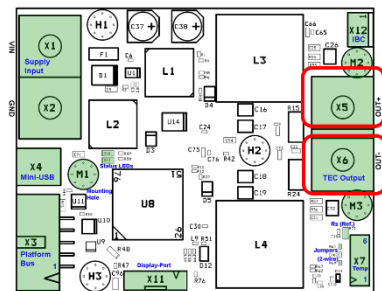

5.3 Connect the Power Supply

- ✗ Set the power supply to a value within the range specified by the datasheet. For this tutorial using TEC-1089, we're going to set 24V.
- ✗ Switch off the power supply.
- ⓘ The power supply must be able to provide enough electric power.
- ✗ Connect the TEC Controller to the power supply at X1 (24V) and X2 (ground).
- ✗ Switch on the power supply.



- Q Now that we have everything connected and prepared, our setup looks like this:

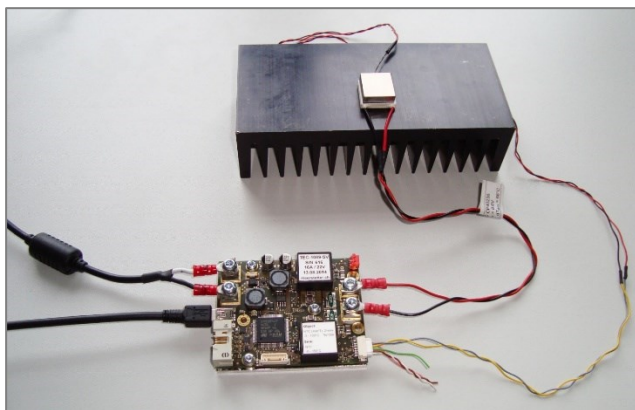

- Q The green LED starts flashing continuously on the TEC Controller.
- Q The TEC Configuration Software displays "Connected" in the bottom-left corner and the "Connection Status" indicator is green.
- Q The "Device Status" in the middle is amber and displays "Ready".

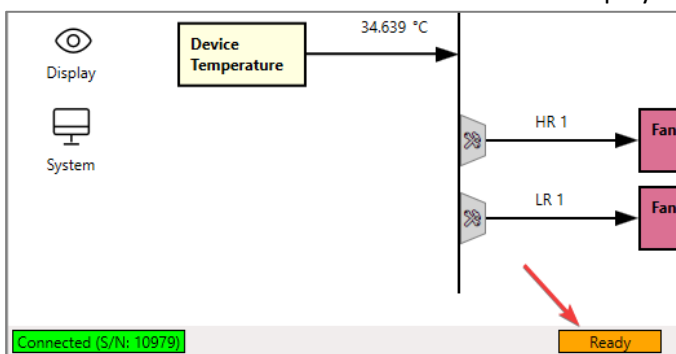

- Q General information about the connected TEC Controller is displayed in the "System" window, which can be opened by the corresponding window in the main window or through the "View" menu in the menu bar.

System Parameters	
Device Type	1089
Hardware Version	2.10
Serial Number	10979
Firmware Version	6.00
Firmware Build Number	704
Min Version for FW Downgrade	6.00
UniquelD	3832-3039-3439-4710-0035-0030

- i If an error occurs, the "Device Status" will turn red and display "Error". While hovering over the "Device Status" field a tooltip will appear which contains further information like the specific error number as well as an error description that may contain possible remediation steps. The error can be cleared by performing a "Reset" action on the controller, which can be done by clicking on the "Device Status" field or by power cycling the TEC Controller.

- Q The following picture shows an example of what is displayed in the tooltip when the TEC Controller is in an error state:

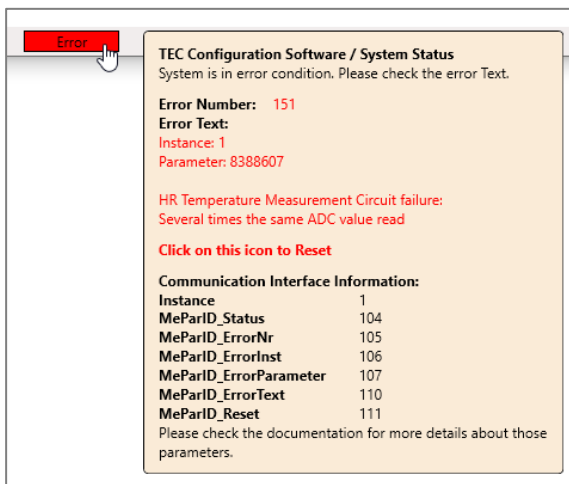

6 Software Setup

6.1 Default Configuration

- ① We assume that you set up a new TEC Controller with factory defaults.
- ✗ If not, look for the default configuration in the "TEC Software vX.YZ Additional" folder you have downloaded from our website (5216x TEC Default Config.xml).
- ✗ Load the default configuration by clicking on "File → Import Config" in the menu bar of the main window of the TEC Configuration Software.
- 🔍 The new values appear in the text fields. They are not yet active on the TEC Controller until a "Write Config" action has been performed.
- 🔍 If a field contains unsaved changes an orange circle will appear next to it. While hovering over this circle one can see what the old value of this field was and by clicking on it the old value can be restored. Furthermore, if there are unsaved changes present the field in the bottom-right corner in any window will display the text "Unsaved parameters" and while hovering over it will list all parameters that contain unsaved changes.
- ✗ Save the changed settings to the TEC Controller by either pressing the "Enter" key while the focus is set on a parameter control field or by clicking on "Device → Write Config" in the menu bar of the main window or by clicking on the "Unsaved parameters" field in the bottom-right corner of any window of the software.
- ① Generally, you have to set values by typing them into the corresponding fields and by performing a "Write Config" action to save them to the TEC Controller.

6.2 Temperature Measurement

- ① We use a 10K NTC sensor with a B value of 3988K (beta value). In our case, the values for the sensor already correspond to the default settings. If you use another NTC sensor, you will have to set the values given by the datasheet of the sensor.
- ① For Pt100 or Pt1000 sensors the TEC Controller will use internally stored settings.
- ① If a Pt100/1000 sensor is used, 4-wire sensing is used for higher precision. In this case the assembly is done according to the schematic on the right side. Thus, two wires are soldered to each pin of the sensor.
- ✗ If you are not using a NTC 10K B = 3988K sensor, set "NTC Sensor Characteristics" in the "Temperature Conversion" box within the "HR Input 1" window by defining the three resistance values for the corresponding temperature points, given by the datasheet of the sensor.

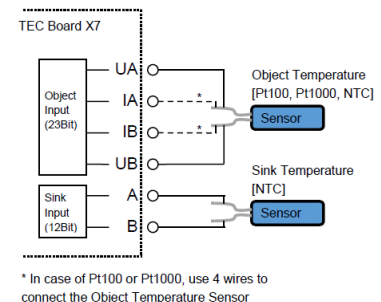

Temperature Conversion	
Conversion Type	NTC
NTC Sensor Characteristics	
T High	60 °C
R High	2488 Ω
T Middle	25 °C
R Middle	10000 Ω
T Low	0 °C
R Low	32650 Ω
Temperature Calibration	
Offset	0 °C
Gain	1

- ❏ Check whether the currently measured temperature in the "HR Input 1" window shows realistic values. The value of "Measured Temperature" (Parameter ID 1045) should be approximately equal to the ambient temperature.

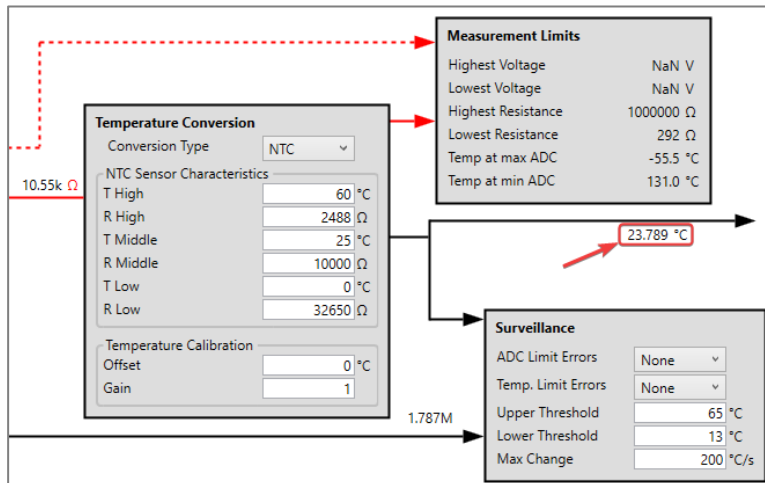

6.3 Peltier Element Characteristics

- ❏ The "Peltier Characteristics" settings in the "Temperature Controller" window are values given by the datasheet of the Peltier element. These values cannot be used to limit the output, but they affect the temperature control behavior of the TEC Controller.
- ✗ Search for the two parameters I_{max} and dT_{max} in the datasheet of your Peltier element. In our case I_{max} is 4A and dT_{max} is 66°C, respectively.
- ✗ In the "Peltier Characteristics" box, put the two parameters in the corresponding fields.
- ✗ Make sure that the selected "Polarity" option is set to "Cooling".
- ❏ The "Thermal Model Selection" should be set to "Peltier, Full Control", which means that the controller can heat and cool the object using the Peltier element.

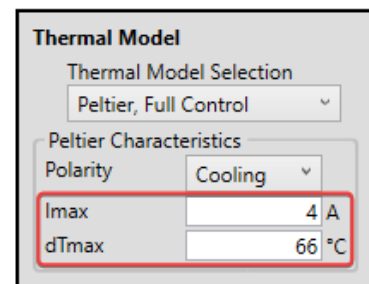

6.4 Temperature Controller

6.4.1 Target Temperature

- ❏ Our goal is now to keep an object at a constant temperature. First, we set the control parameters, then we must limit the output of the TEC Controller.
- ✗ Open the "Temperature Controller" window by clicking on the purple button that contains the text "CH1" (this stands for "Temperature Controller Channel 1") in the middle in the main window.
- ✗ In the "Temperature Controller" window, set the "Target Temperature" to 15°C.

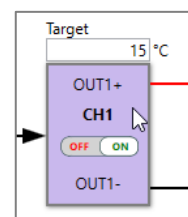
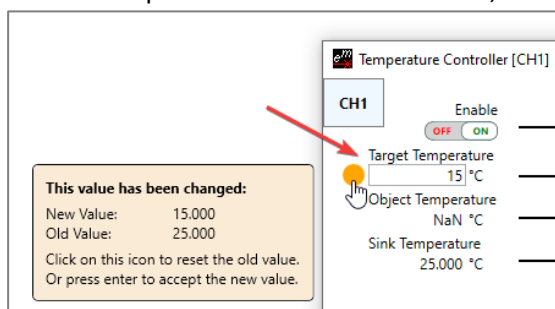

- ❏ The "Target Temperature" can also be adjusted in the main window.

6.4.2 Operation Limits

- ① Now we need to set the output limits for the operation of the Peltier element.
- ① Limits are set depending on the application. However, generally the voltage limitation should be set approx. 1V over the V_{max} of the Peltier element and the temperature limitation should be set so that it cannot be reached in normal operation mode.
- ✗ Set "Output Stage Input Selection" selector to the left of the "Output Stage" rectangle in the "Temperature Controller" window to "Temperature Controller":

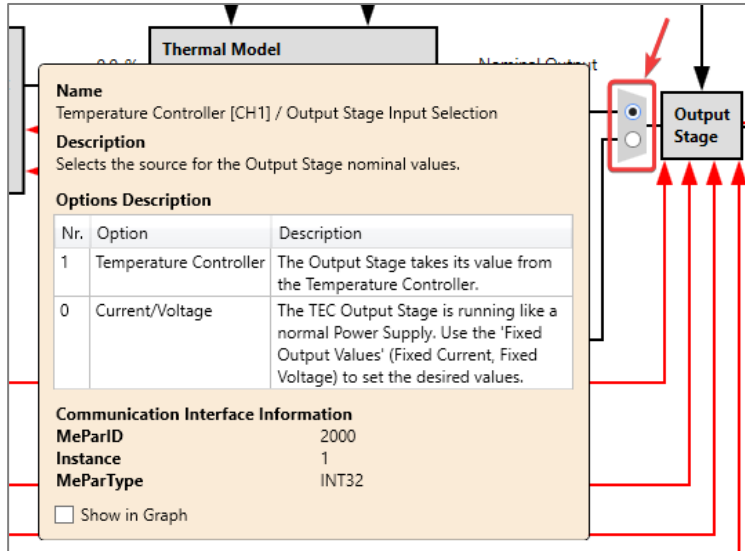

- ✗ For this example, we set the output stage limitations and error thresholds to the following values:

"Output Current Limit": 1A
 "Output Voltage Limit": 9.6V
 "Output Current Error Threshold": 4.8A
 "Output Voltage Error Threshold": 12V

- ✗ Set "Upper Threshold" and "Lower Threshold" in the "Surveillance" box of the "HR Input 1" window to a range that includes your object temperature. Those limits will however only be active when the "ADC Limit Errors" or "Temp. Limit Errors" parameters are not set to "None".

- ① The "Output Current Limit" should be set to 1A at the first startup and then changed later if necessary. Generally, the "Output Current Limit" should be equal to 0.7 times I_{max} of the Peltier element.
- ① Error thresholds should be set approximately 20% above the corresponding limits. An error is generated, and the TEC Controller is stopped if a value reaches its threshold.

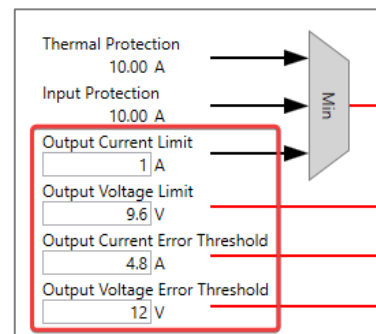

6.4.3 Functionality Check

- ✗ In the tab "Temperature Controller" window, set "Output Enable" to "ON".
- ① Toggling "Output Enable" on and off can also be done in the main window.

- ✘ While hovering over the "Object Temperature" parameter in the "Temperature Controller" window, enable the "Show in Graph" option in the tooltip that is displayed.

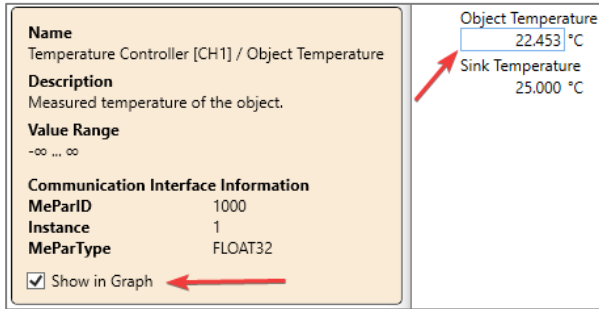

- 🔍 Observe the temperature changes in the "Graph" window. The temperature converges to 15°C.

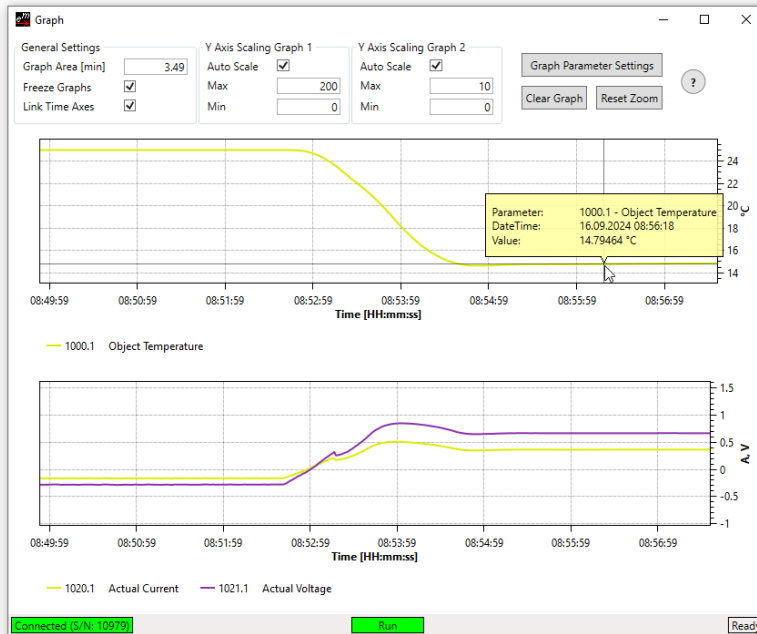

- 🔍 In the main window and the "Temperature Controller" window the "Object Temperature" parameter next to the "Load" will have an amber background if the target temperature has not yet been reached.
- 🔍 If the measured "Object Temperature" equals the target temperature the background is green.

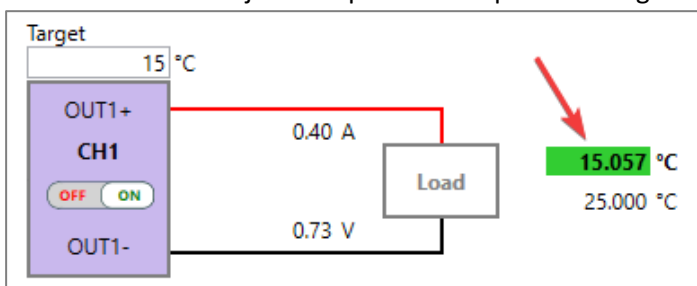

- 🔍 There can be a small difference between the desired target temperature and the measured object temperature.
- 🔍 If the temperature is changing in the wrong direction, the Peltier element is connected the wrong way. Switch the wires at X5 and X6 and test your setup again. See step 5.2 for more information about how to connect the Peltier element.

6.5 Auto Tuning

- ① To be able to precisely control the object temperature we must optimize the control system of the TEC Controller. This can be done automatically by using the integrated PID tuning function in the "Auto Tuning" window.
- ✗ In the "Temperature Controller" window or the main window make sure that the "Output Enable" option of the respective channel is set to "ON".

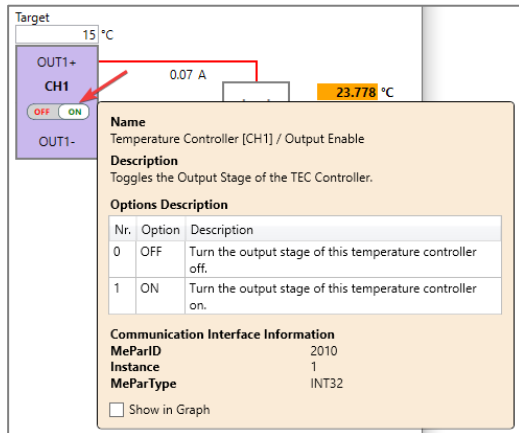

- ✗ Check in the "Graph" window whether the chosen target temperature has approximately been reached and whether it is stable.
- ✗ Click on the "Start" button in the "Auto Tuning" window.

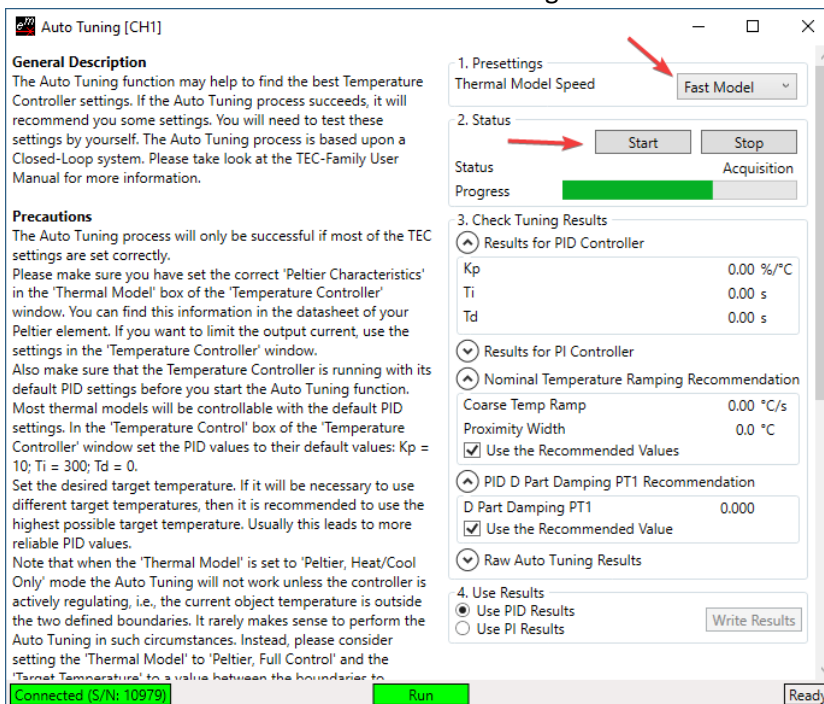

- 🔍 The Auto Tuning function now tries to optimize the system and seeks optimum PID controller values.

- You can observe the progress of the Auto Tuning process in the "Graph" window. By default, no parameters are shown in the graphs, they can be enabled in the "Application Settings" window, which can be accessed by clicking on the "Graph Parameter Settings" button:

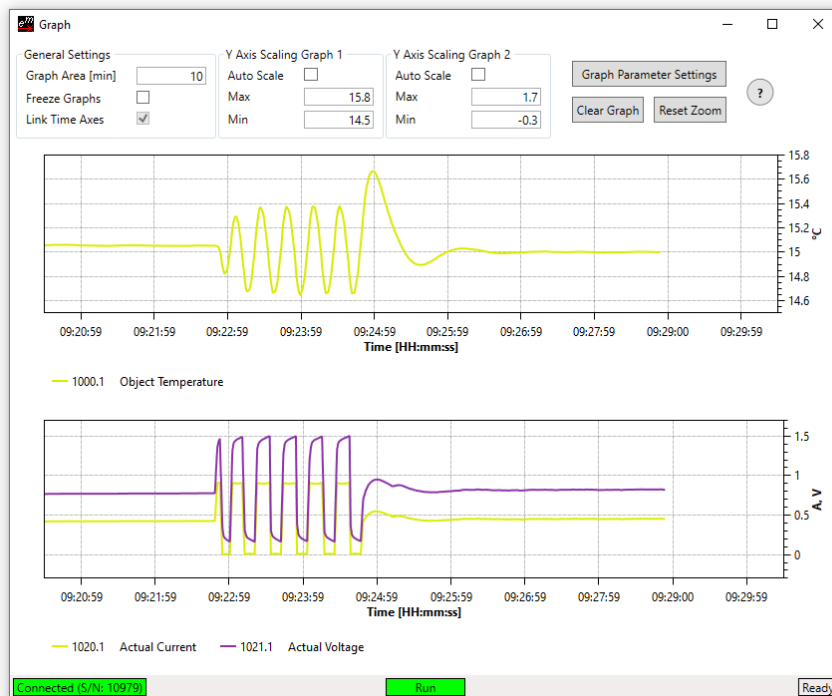

- 09:22:50 Auto Tuning started.
- 09:25:00 Auto Tuning finished.
- 09:25:20 New PID values applied.

- ✗ If the tuning was successful, the found values can be saved by clicking on "Write Results" back in the "Auto Tuning" window.

- ✗ If it was not successful, try the option "Slow Model" as "Thermal Model Speed".
- ① The system will use the found PID parameters from now on to control the object temperature if the tuning was successful. The PID parameters can be further manually adjusted in the "Temperature Controller" window.

7 Further Information

Congratulations! Your TEC Controller should now be working, and you should be able to set up a simple application with your TEC Controller.

Please refer to the [TEC-Family User Manual](#) for detailed information about the TEC Configuration Software, the TEC Controllers, and to find additional troubleshooting resources.

[The TEC / Peltier Element Design Guide on our website](#) provides more information about how to design a thermoelectric application including calculations, choosing Peltier elements, temperature sensors, heat sinks and power supplies.

A Change History

Date of change	Version	Changed / Approved	Firmware Version	Change / Reason
16 September 2024	N	XF / ML	v6.00	<ul style="list-style-type: none">• Add Change History• Changed all software related instructions and pictures from the TEC Service Software to the TEC Configuration Software