

Datasheet - TEC Controller TEC-1161-4A TEC Controller TEC-1161-10A

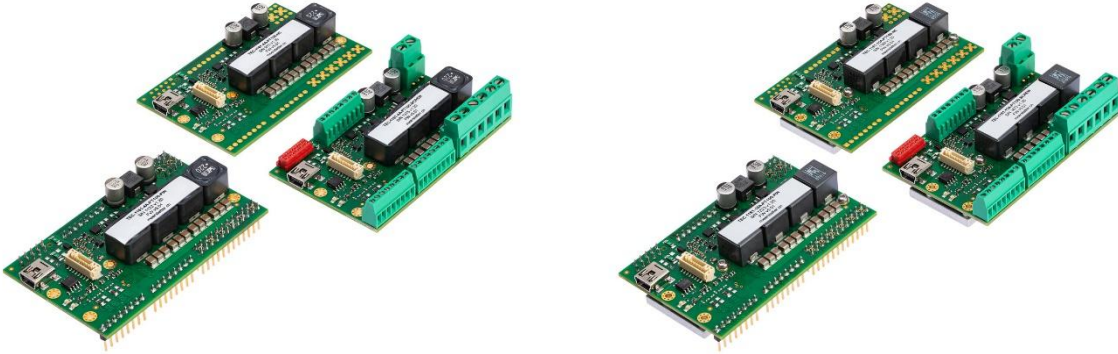

Support / First Steps

Meerstetter Engineering provides technical support for all products and helps you to integrate a product into your solution. Most of your questions should be solved by reading the provided [user manuals](#) of the corresponding product or the [FAQ](#) (frequently asked questions).

For further help or if you have any other questions, please do not hesitate to contact us. We are happy to help you. You can contact us by email support@meerstetter.ch.

Meerstetter's Product Family Compatibility

The Meerstetter LDD- and TEC-Families have been developed to work along with each other. They share the same platform bus, communication protocol and hardware architecture. See the following table for an overview of the LDD- and TEC-Families.

LDD-Family		
LDD-1321	0-1.5 A / 0-14 V	CW, Add on TEC Controller available
LDD-1301	0-20 A / 0.5-45 V	1 ms - CW
LDD-1303	0-20 A / 1-120 V	1 ms - CW
LDD-1137	0-75 A / 0-70 V	0.5 μ s - CW, modulated, QCW and pulsed modes
LDD-1124-SV	0-1.5 A / 0-15 V	1 μ s - CW, modulated, QCW and pulsed modes
LDD-1121-SV	0-15 A / 0-15 V	1 μ s - CW, modulated, QCW and pulsed modes
LDD-1125-HV	0-30 A / 0-27 V	1 μ s - CW, modulated, QCW and pulsed modes
TEC-Family		
TEC-1092	\pm 1.2 A / \pm 9.6 V	Micro, single channel
TEC-1091	\pm 4 A / \pm 21 V	Small, single channel
TEC-1089-SV	\pm 10 A / \pm 21 V	Medium, single channel
TEC-1162	\pm 5 A / \pm 56 V	Medium-high, single channel
TEC-1090-HV	\pm 16 A / \pm 30 V	Large, single channel
TEC-1163	\pm 25 A / \pm 56 V	Extra-large, single channel
TEC-1161-4A	2 x (\pm 4 A / \pm 21 V)	Small, dual channel
TEC-1161-10A	2 x (\pm 10 A / \pm 21 V)	Medium, dual channel
TEC-1122-SV	2 x (\pm 10 A / \pm 21 V)	Medium, dual channel
TEC-1166	2 x (\pm 5 A / \pm 56 V)	Medium-high, dual channel
TEC-1123-HV	2 x (\pm 16 A / \pm 30 V)	Large, dual channel
TEC-1167	2 x (\pm 25 A / \pm 56 V)	Extra-large, dual channel

OEM TEC Controller



Description:

The TEC-1161 is a specialized TEC Controller / power supply able to precision-drive two Peltier elements.

Each channel features a true bipolar DC current source for cooling / heating, six temperature monitoring inputs (2x high resolution, 4x low resolution) and intelligent PID control with auto tuning. The TEC-1161 is fully digitally controlled, it's hard- and firmware offer numerous communication and safety options.

The included PC-Software allows configuration, control, monitoring, and live diagnosis of the TEC Controller via USB and RS485. All parameters can be saved to non-volatile memory.

For the most straightforward applications, only a power supply, Peltier elements and at least one temperature sensor need to be connected to the TEC-1161. After power-up the unit will operate according to pre-configured values. (In stand-alone mode no control interface is needed.)

The TEC-1161 can handle either Pt100, Pt1000, NTC or Voltage temperature probes. For highest precision and stability applications a Pt100 / 4-wire input configuration is recommended. Analog measurement circuit is factory calibrated.

Low resolution temperature inputs allow the connection of NTC probes that are located on the heat sinks of the Peltier elements. This additional data is used to compensate for parasitic thermal conduction of Peltier elements. Also, it allows the control of external heat sink cooling fans.

The heating and cooling power is optimized by proprietary thermal management routines based on power balance models (for Peltier elements and resistive heaters).

The TEC-1161 two independent channels may also be operated in parallel to either drive two individual or one common load (current doubling).

Further functionality includes: Smooth temperature ramping, thermal stability indication and auto gain (NTC probes). The PC-Software allows data logging and configuration import/export.

Features

Input Characteristics:

- DC Input Voltage: 5 to 24 V

Output Characteristics:

- Voltage: up to ± 21 V
- Current: up to ± 10 A

Main Features:

- Temperature Sensor Types: Pt100, Pt1000, NTC, Voltage
- Temperature Precision / Stability: <0.01 °C
- Temperature Control & Measurement Frequency: 1 Hz, 10 Hz, 90 Hz
- Communication bus compatible
- Configuration / Diagnosis over all communication interfaces with PC Software
- PCB mountable version available
- Measurement Inputs freely assignable to any Output Channel
- Bipolar output channels can be split into unipolar channels

Operation Modes:

- Stand-alone operation
- Remote-controlled over USB, CAN, RS485, I/O
- Script-controlled over lookup table (thermal cycling)

Driver Modes:

- DC power supply (bipolar)
- Temperature control: PID settings, auto tuning, optional cool/heat-only or resistor heating modes

Data Interfaces:

- USB
- RS485 (Half-Duplex)
- CANopen CiA 301

General Purpose I/O Features:

- Configurable as input to control TEC-1161 (Enable, Temperature up / down etc.)
- Configurable as output to monitor TEC-1161 (Error Indication, Temperature Stable Indication etc.)

Special Requirements / More Information:

- Please contact us for additional information or customization.

Absolute Maximum Ratings

Supply voltage (DC)	25.5 V
---------------------	--------

Operating Ratings

Temperature	-40 – 90 °C
Humidity	5 – 95 %, non-condensing

Operating Characteristics

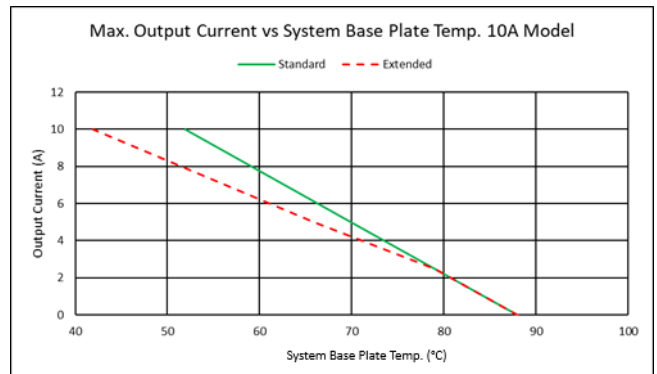
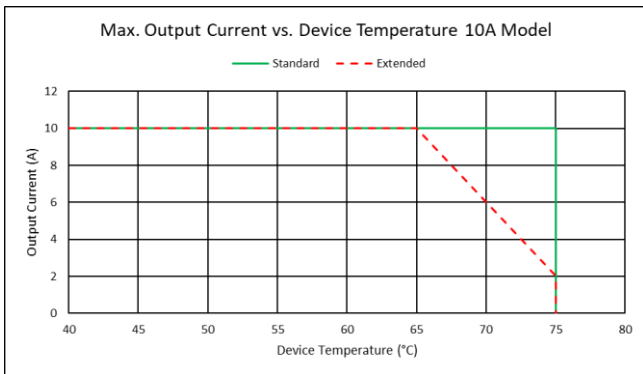
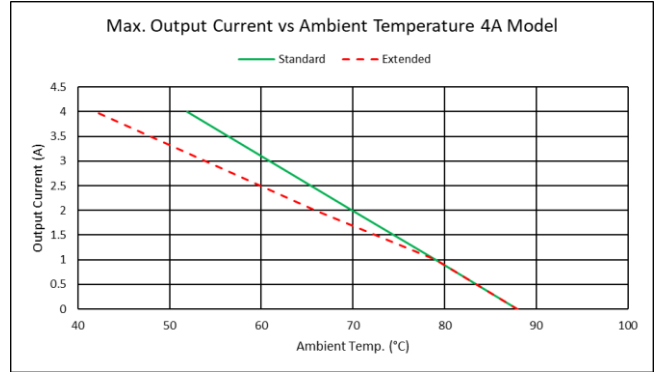
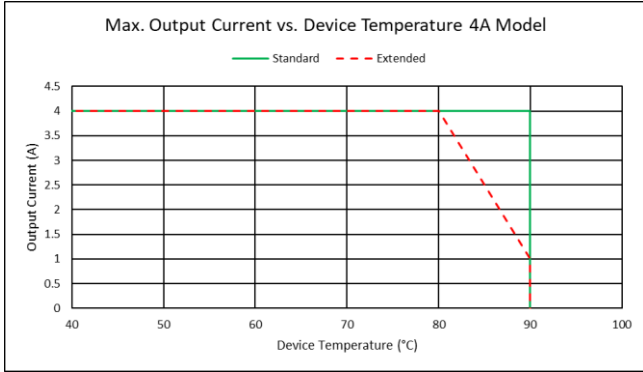

Standard or Extended Device Temperature Mode can be set as software setting. The right Diagram shows the situation with an external 3.3Ω resistor (4A Model) or a 1.65Ω resistor (10A Model). No forced air flow was present.

Efficiency

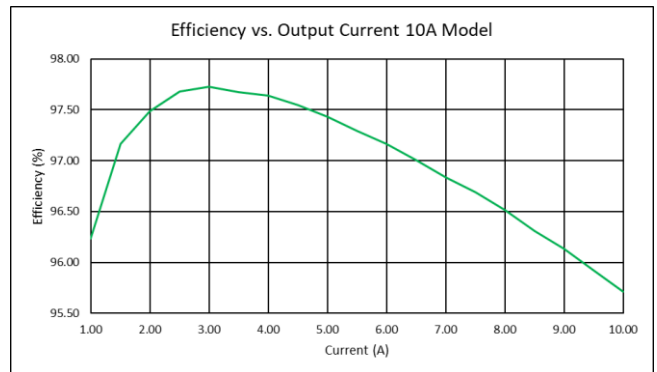
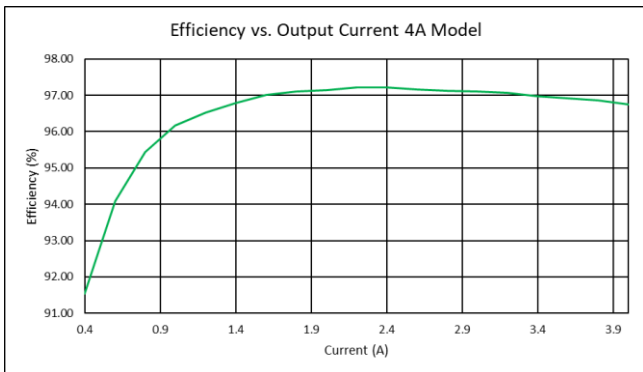

The Efficiency measurements were done at 21V output voltage and a device temperature of 60°C. The ambient temperature was 23°C, no forced air flow was present.

Electrical Characteristics 4A Model

Unless otherwise noted: $T_A = 25$ °C, $U_{IN} = 24$ V, $R_{load} = 3.3$ Ω

Symbol	Parameter	Test Conditions / Hints	Min	Typ	Max	Units
DC Power Supply Input:						
U_{IN}	Supply voltage	Measured directly on power input terminals	4.9		24	V
U_{IN} Ripple	Ripple tolerance	U_{IN} never below $U_{IN_{min}}$ or above $U_{IN_{max}}$			300	mV _{PP}
I_{IN}	Max input current	Hint: Software limitation			10	A
Output (per Channel):						
I_{OUT}	Bipolar current				± 4	A
U_{OUT}	Bipolar voltage	U_{OUT} is maximum $\sim 0.9 * U_{IN}$			± 21	V
I_{OUT}	Unipolar current ¹				4	A
U_{OUT}	Unipolar voltage ¹	U_{OUT} is maximum $\sim 0.9 * U_{IN}$			21	V
U_{OUT} Ripple	Voltage ripple	@ 4 A			100	mV _{PP}
System Characteristics:						
$\eta_{50\%}$	Power efficiency	@ 50 % load (10.5 V, 4 A)		94		%
$\eta_{100\%}$	Power efficiency	@ 100 % load (21 V, 4 A)		96		%
Output Monitoring: (I_{OUT} Resolution is 1.46 mA; U_{OUT} Resolution is 6.1 mV)						
I_{OUT} Read	Precision	@ 3.8 A		1	5	%
U_{OUT} Read	Precision	@ 15.0 V		1	3	%

Electrical Characteristics 10A Model

Unless otherwise noted: $T_A = 25$ °C, $U_{IN} = 24$ V, $R_{load} = 1.65$ Ω

Symbol	Parameter	Test Conditions / Hints	Min	Typ	Max	Units
DC Power Supply Input:						
U_{IN}	Supply voltage	Measured directly on power input terminals	4.9		24	V
U_{IN} Ripple	Ripple tolerance	U_{IN} never below $U_{IN_{min}}$ or above $U_{IN_{max}}$			300	mV _{PP}
I_{IN}	Max input current	Hint: Software limitation			22	A
Output (per Channel):						
I_{OUT}	Bipolar current				± 10	A
U_{OUT}	Bipolar voltage	U_{OUT} is maximum $\sim 0.9 * U_{IN}$			± 21	V
I_{OUT}	Unipolar current ¹				10	A
U_{OUT}	Unipolar voltage ¹	U_{OUT} is maximum $\sim 0.9 * U_{IN}$			21	V
U_{OUT} Ripple	Voltage ripple	@ 10 A			350	mV _{PP}
System Characteristics:						
$\eta_{50\%}$	Power efficiency	@ 50% load (10.5 V, 10 A)		93		%
$\eta_{100\%}$	Power efficiency	@ 100% load (21 V, 10 A)		95		%
Output Monitoring (I_{OUT} Resolution is 3.5 mA; U_{OUT} Resolution is 6.1 mV)						
I_{OUT} Read	Precision	@ 9.8 A		1	5	%
U_{OUT} Read	Precision	@ 15.0 V		1	3	%

¹ In unipolar mode, the total output power is doubled in comparison to the bipolar mode, but the controller input current is limited to I_{IN} , which limits the total available output power. The controller limits the output current for each channel dynamically if the max input current limit is reached.

Output Safety Characteristics

Unless otherwise noted: $T_A = 25$ °C, $U_{IN} = 12$ V

Symbol	Parameter	Test Conditions / Hints	Min	Typ	Max	Units
Output Stage Protection Delays:						
t_{OFF}	Short circuit	Full load condition		10	30	μ S
t_{OFF}	Power system limits	Current and voltage limits			200	μ S
Output Stage Current Supervision: (If the $OUT+$ and $OUT-$ currents differ too much, an error is generated)						
I_{OUT_DIFF}	Error threshold			120		mA

High Resolution Temperature Measurement Characteristics (NTC Probes)

NTC thermistor resistive input characteristics translate into temperature ranges valid for only one type of NTC probe. Below example is given in the case of an NTC B_{25/100} 3988K R₂₅ 10k temperature sensor.

Symbol	Parameter	Test Conditions / Hints	Min	Typ	Max	Units
R _{HR, RANGE}	ADC Auto Gain PGA = 1 or 8 or 32	Corresponding temperature range	73	194.3 to -55.5	1M	Ω °C

R_{HR, RANGE} is the resistance range of the NTC sensor

High Resolution Temperature Measurement Characteristics (Pt100 and Pt1000 Probes)

Measurement configuration = 23 bit / 4-wire / unshielded cable <50 mm

Symbol	Parameter	Test Conditions / Hints	Min	Typ	Max	Units
T _{HR, RANGE}	Range	Range is extendable upon request Extended measurement range is -193°C ... +787°C	-220		+200	°C
T _{HR, PREC}	Precision	(EN 60751 / IEC 751)		0.005		°C
T _{HR, COEFF}	Temp. Coefficient	Relative to device temperature			1.6m	°C/K
T _{HR, NOISE}	Value Noise	Reference measurement fluctuations while output stage operating @70% load		0.005		°C
T _{HR, REP}	Repeatability	Repeated measurements of reference resistors after up to 3 days		0.008		°C

High Resolution Temperature Measurement Characteristics (Voltage Measurement VIN1/2)

Sensors with linear Voltage/Temperature output

Symbol	Parameter	Test Conditions / Hints	Min	Typ	Max	Units
V _{SENS, DIFF}	Range	Differential input voltage Temperature range depends on sensor used	-2.039		2.039	V
V _{HRUx, ABS}	Range	Absolute input voltage	-0.1		5.1	V

Low Resolution Temperature Measurement Characteristics (NTC only)

T_A = 25 °C, measurement configuration = 12 bit / 2-wire / unshielded cable <50 mm, °T probe = NTC B_{25/100} 3988K R₂₅ 10k

Symbol	Parameter	Test Conditions / Hints	Min	Typ	Max	Units
R _{LR, RANGE}	Range	Corresponding temperature range:	50	214 to -8.1	49781	Ω °C

General Purpose Digital I/O Characteristics (GPIO1 ... GPIO10)

Unless otherwise noted: $T_A = 25\text{ }^\circ\text{C}$

Symbol	Parameter	Test Conditions / Hints	Min	Typ	Max	Units
Input Characteristics:						
U_{IH}	Logic high input threshold		2.38			V
U_{IL}	Logic low input threshold				0.93	V
U_{IMAX}	Maximum input voltage		-0.5		5.5	V
Output Characteristics: (Microprocessor)						
U_{OH}	Logic high output voltage	Output current 8 mA	2.8		3.3	V
U_{OL}	Logic low output voltage	Input current 8 mA			0.4	V
Z_{OUT}	Output Impedance		110	120	150	Ω
I_{OUT}	Output Sink or Source Current			±8	±20	mA
ESD Protection: (Between Processor and Connector)						
V_{PP}	ESD discharge	IEC61000-4-2		18		kV
R_A	Series resistance		85	100	115	Ω

Auxiliary Connector X5 Power Supply Output Characteristics

Unless otherwise noted: $T_A = 25\text{ }^\circ\text{C}$

Symbol	Parameter	Test Conditions / Hints	Min	Typ	Max	Units
Input Characteristics:						
U_{OUT}	Output voltage	Output current 50 mA	4.4	4.5	5	V
I_{OUT}	Output current		0	150	200	mA
U_{IMAX}	Maximum input voltage		-0.5		5.5	V

Pin Configuration Screw Connectors TOP View

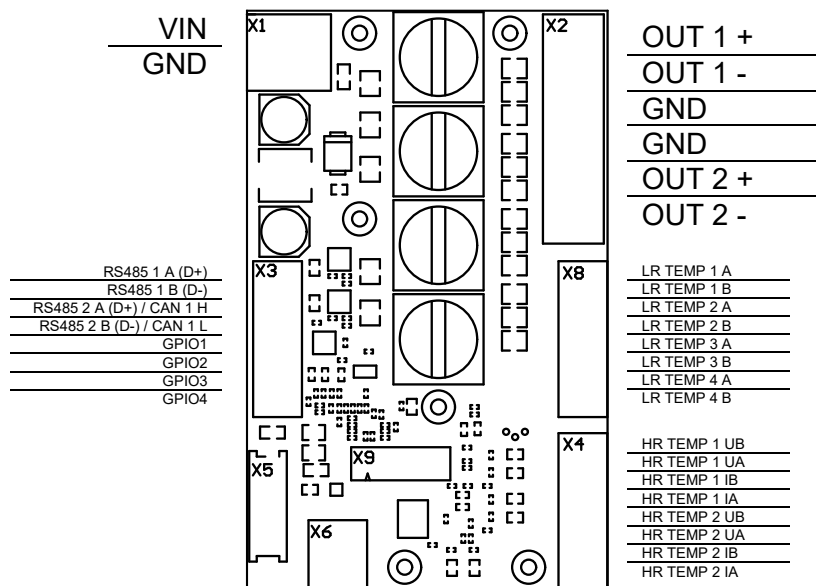

Matching Receptacles for the PIN Configuration

The following receptacles can be used for the TEC-1161 in the -PIN Configuration:
Manufacturer: MILL-MAX MANUFACTURING Part Number: 801-43-050-10-001000
The receptacles need to be broken up into the appropriate length.

Screw Connector Specifications X1 and X2

Parameter	Min	Typ	Max	Units
Wire Size (Mechanical Limit, current carrying capacity not considered)	0.05		2.5	mm ²
Torque		0.5	0.6	Nm
Stripping Length		6.5		mm

Screw Connector Specifications X3, X4 and X8

Parameter	Min	Typ	Max	Units
Wire Size (Mechanical Limit, current carrying capacity not considered)	0.05		0.5	mm ²
Torque		0.1		Nm
Stripping Length		5		mm

Temperature Sensor Connection X4 and X8

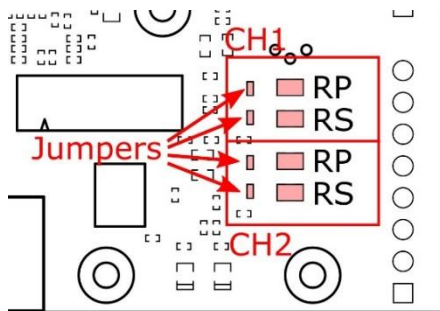

The jumpers are used for the 2/4 Wire configuration. For the values of RS and RP please refer to the TEC-Controller User Manual.

Pin Configuration Pinheader Connectors TOP View

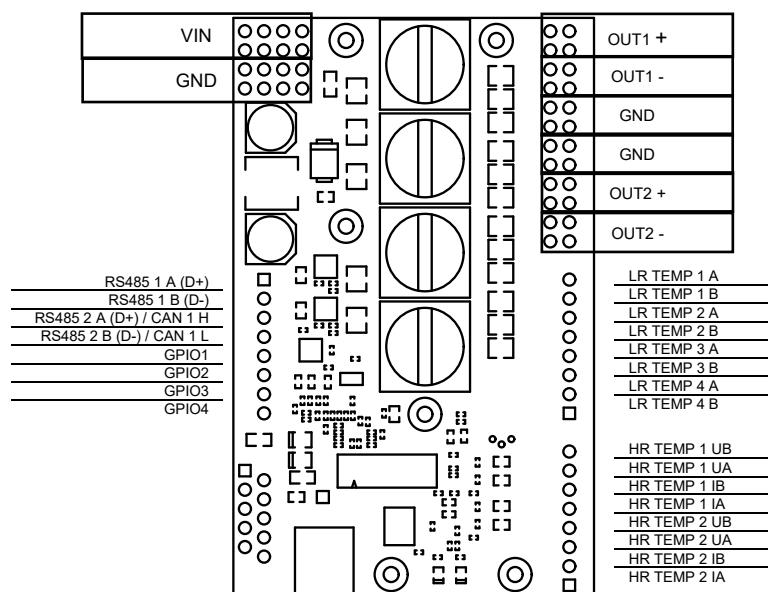

Pin Configuration Auxiliary IO Connector X5

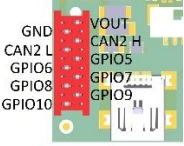
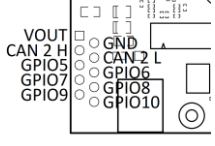
Mini-Module Plug	Pin-Header
 <p>GND CAN2 L GPIO6 GPIO8 GPIO10</p> <p>VOUT CAN2 H GPIO5 GPIO7 GPIO9</p>	 <p>VOUT CAN 2 H GPIO5 GPIO6 GPIO7 GPIO8 GPIO9 GPIO10</p>
<p>Plug used: Würth MINI MODULE Part Number: 690367181072 Matching Connector: Würth Part Number: 690157001072</p> <p>CANopen is only available on CAN1.</p>	

Mini USB Connector X6

The Mini USB Connector X6 can be used to communicate with the TEC Controller using the meCom communications protocol or the software. It is electrically isolated.

Display Connector X9

The Connector X9 can be used to connect one of the OLED Displays available from Meerstetter (DPY-1113, DPY-1114 or DPY-1115).

Temperature Sensor Connection X4 and X8

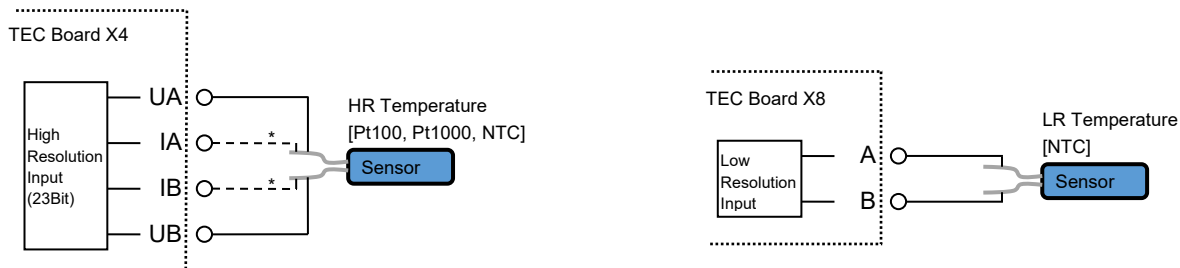

* In case of Pt100 or Pt1000, use 4 wires to connect the High Resolution Temperature Sensor

Further information can be found [here](#).

Dimensions

Top View

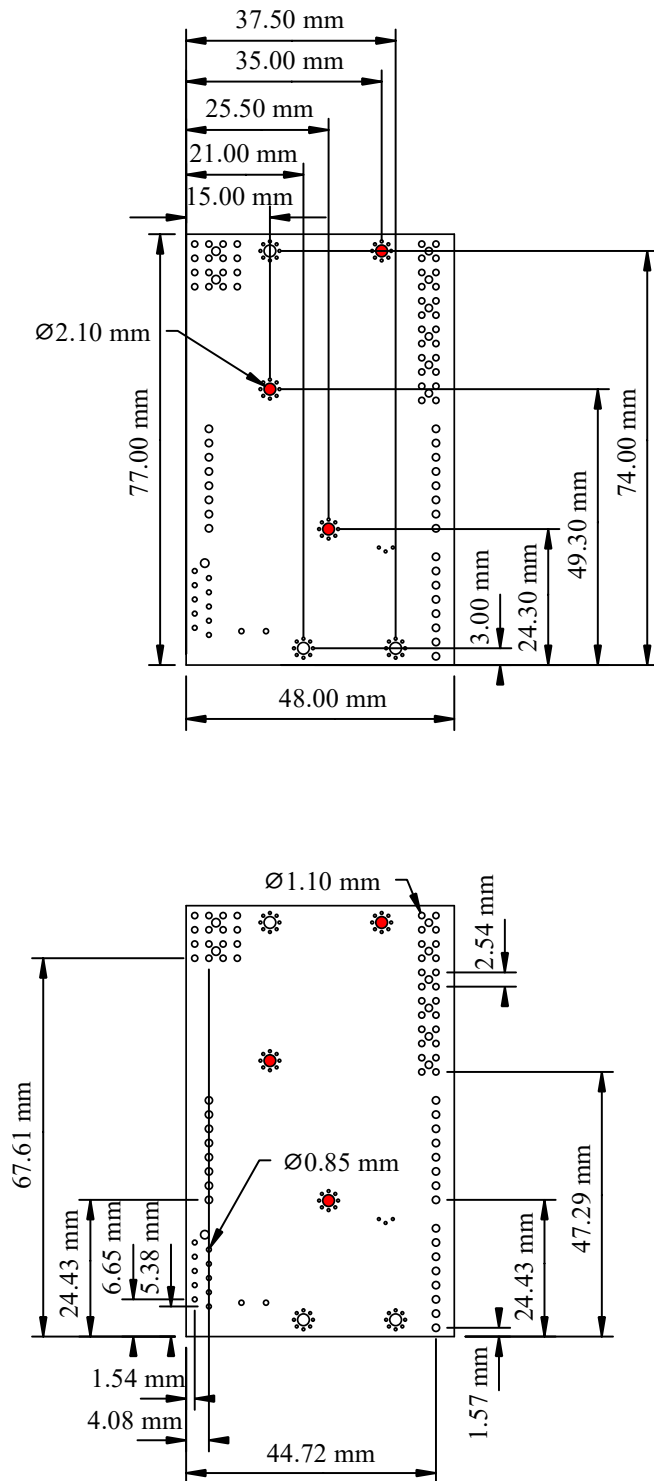

The holes marked in red are used to mount the aluminum baseplate for the 10A version and are therefore not available for mounting purposes in this version.

Operation Modes / Theory of Operation

The TEC-1161 is an OEM precision TEC Controller that is available with Screw Terminals or as a PCB mountable device. Its basic operation status is visually indicated by on-board green and red LEDs and their blinking pattern.



SCREW Screw terminal equipped Version



PIN PCB mountable Version

Status information can be polled at any time by industry standard RS485 connection or by USB (see box below). The TEC-1161 can also operate in a remotely controlled manner, with parameters adjusted on the fly. Scripting capability by sequential lookup table read-out is supported.

Configured as a DC power-supply, the TEC-1161 can handle current and voltage settings. In the remote-control case, temperature data may be passed on to be processed by the host.

Configurable parameters further include sensor linearization (Pt100 / Pt1000) and Steinhart-Hart modeling (NTC), temperature acquisition hardware calibration, Peltier element modeling, PID controller auto tuning, nominal temperature ramping, current, voltage and temperature limits, error thresholds, etc. Please refer to the TEC Controller User Manual (Document 5216) for further information.

TEC-1161 Ordering Information, Hardware Configuration

Example Configuration: **TEC-1161-4A-PT100-SCREW-CSX**

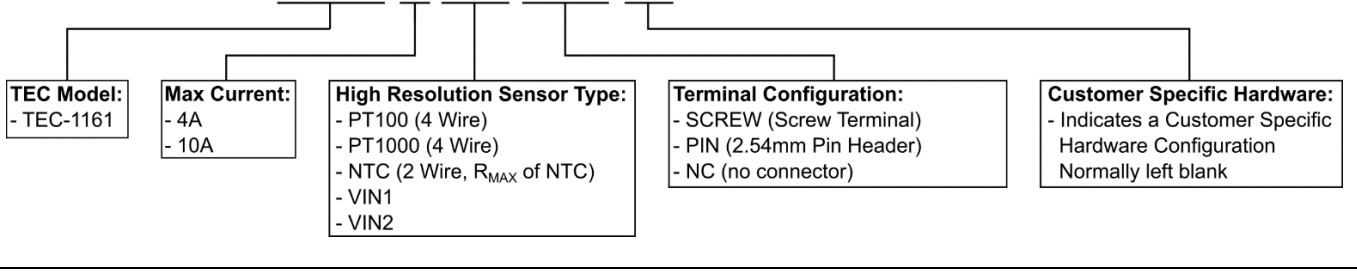

High Resolution Sensor Type:

NTC: By default, we mount an NTC1M. If you require an older version (NTC18K, NTC39K or NTC56K), please write which one you need in the comment section of your order or contact us: contact@meerstetter.ch.

Thermocouple:

To use our TEC Controllers with thermocouples type K, you need a TCI-1181 in addition to the TEC Controller with a VIN1 or VIN2 High Resolution Sensor Type configuration.

Display Unit:

It is possible to connect a small or big OLED 2x16 / 4x20 character display directly to the X9 connector of the device. Please visit the DPY-111x product pages on our website for further information.

Customization:

Many hardware and software features of the TEC-1161 are customizable upon request. Please contact Meerstetter Engineering with your enquiry.

Change History

Date of change	Version	Changed/ Approved	HW- Version	Change / Reason
14 October 2024	G	XF / ML	v1.20 / v1.21	<ul style="list-style-type: none"> • Add: Change History • Add: New Main Feature: Measurement Inputs are freely assignable to any Output Channel • Add: New Main Feature: Bipolar output channels can be split into unipolar channels • Add: "Unipolar current per channel" and "Unipolar voltage per channel" specifications in "Electrical Characteristics" section • Add: Max Input Current (I_{IN}) specification in Electrical Characteristics section • Del: "Important note" regarding GPIO 9/10 and Low resolution temp. measurement 3/4 not being available removed as they are available as of firmware v6.00
12 February 2026	H	ML / SR	v1.30	<ul style="list-style-type: none"> • Hardware Version changed to v1.30 • Max. Output Current vs System Base Plate Temp. 10A Model: X Axis Title changed