

User Manual – LTR-1200



LDD / TEC 19" Rack Enclosure

Suitable for:

TEC-1089

TEC-1090

TEC-1091

TEC-1122

TEC-1123

TEC-1161

TEC-1162

TEC-1163

TEC-1166

TEC-1167

LDD-1124

LDD-1121

LDD-1125

Third-Party Devices

**meerstetter
engineering** 

 Member of Berndorf Group



Developed, assembled, and tested in Switzerland

Index

1	Device Overview	4
2	Safety Information	5
2.1	Safety Instructions	5
2.2	Intended Use	5
2.3	User Groups	5
2.4	Disposal of Device	5
2.5	Output Limitation	6
3	Functional Description	7
3.1	Device-specific Documentation	7
3.2	Getting Started	8
3.3	Menu Structure	10
3.4	Communication Interfaces	12
4	Technical Data	15
4.1	Elements and Configurations	15
4.2	Front Panel	15
4.3	Back Panel	20
4.4	Error Numbers	22
4.5	Physical Dimensions	24
4.6	License Notice	24
A	Change History	25

Meerstetter Engineering GmbH

Schulhausgasse 12

CH-3113 Rubigen

Switzerland

Phone: +41 31 529 21 00

Email: contact@meerstetter.ch

Meerstetter Engineering GmbH (ME) reserves the right to make changes without further notice to the product described herein. Information furnished by ME is believed to be accurate and reliable. However typical parameters can vary depending on the application and actual performance may vary over time. All operating parameters must be validated by the customer under actual application conditions.

Document 5171E

Release date: 20 May 2025

1 Device Overview

LTR-1200

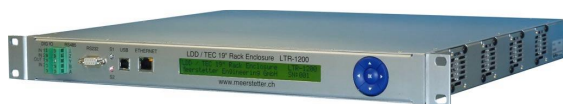

Description:

The LDD / TEC 19" rack enclosure LTR-1200 is a highly configurable, ready-made carrier system facilitating the integration of up to 4 devices belonging to either the LDD-Family of laser diode drivers or the TEC-Family of Peltier/TEC controllers. The system caters for power, cooling and communication. The combination of built-in devices (models, number) is selectable by the customer, their application will dictate the choice (12V, 24V or 36 V) and number of internal DC power supplies. Meerstetter Engineering will take care of the integration and provide a fully configured turnkey solution.

Up to 4 fans drag air sidewise through the rack enclosure. Their speed is managed by intelligent fan control on a dedicated PCB such that air-cooling becomes effective upon prolonged use at high ratings. For table-top operation, the rack mounting brackets can be removed.

The status of the rack enclosure and of the built-in devices are indicated on the front side display (2x40 characters) and by dual color LEDs. The most important settings (parameters of the built-in devices and of the front side data interfaces) can be adjusted over the 5-way navigation switch.

For advanced operation and configuration, all internal devices can be addressed over one of the interfaces; therefore, the originally supplied TEC and/or LDD Service Software's can be used. For continuous monitoring and control by customers' systems, the serial communication protocol 'MeCom' can be used: on one hand, it allows direct control of the each built-in LDD and TEC device, on the other hand it allows polling further information about the overall system status. For fast signals (such as LDD pulse triggering) three digital input lines are available. Also, one digital output is available (e.g. for error indication). The integration of third-party hardware (such as fiber-coupled diode lasers) is possible if dimensional requirements are met.

Features

- Rack Enclosure Size: 1U, 400 mm in depth
- AC Input Voltage: 90–264 V / 47–63 Hz
- Space for Devices: Up to 4 LDD / TEC Drivers; Third-Party Devices (Max 8 Outputs)
- Data Interfaces: Ethernet 10/100 MBit/s
USB
RS485
RS232
- Digital I/O Signals: 3 Digital Inputs
1 Digital Output
- Human Machine Interface (HMI): Backlit 2x40 Character Display and 5-Way Navigation Switch for Local Monitoring and some Main Settings
- Status Indication: 2 LED (Dual Color)
- Forced Air Cooling: Temperature-Dependent Fan Speeds
- Max Ambient Temperature: Full load up to 40 °C
Half load up to 45 °C
- Humidity: 5–95% non-condensing
- IP Code (per IEC 60529): 20

Advanced Operation

- Remote Control: LDD / TEC Service Software and 'MeCom' Protocol

Applications

- Optics (Laser Diodes, Crystals, ...):
e.g. autonomous turn-key solutions for comprehensive control (supply, cooling) of ps lasers
- Electronics (Detectors, RF References, ...):
e.g. low-noise camera cooling
- Instrumentation (Microscopy, Materials, Biochemistry, ...):
e.g. precision multi-temperature control (thermal zones)

2 Safety Information

The following parts of the user manual for the LTR-1200 rack (“device”) from Meerstetter Engineering GmbH (“manufacturer”) contain important information for the owner and person operating the device (“user”).

2.1 Safety Instructions

To ensure that the device stays in that state and a safe operation is guaranteed, the user must read and follow safety instructions as well as usage instructions.

Opening and modifying the device is not permitted. For modifications and adaptations, the user must contact the manufacturer.

The device must be stored in a dry place at room temperature.

In the following cases the user must put the device out of operation and further usage is no more permitted. For repair measures the manufacturer must be contacted.

- External damage of the casing
- Damage of any connectors
- Loose parts inside the device
- Non-operable device
- Long-time storage in non-optimal conditions (e.g. outdoors or in humid environments)

2.2 Intended Use

The device is—depending on the configuration—solely intended as driver for Peltier elements or laser diodes.

- Claims against the manufacturer cannot be made for damages caused by inappropriate use of the device.
- The user is responsible for any damages resulting from inappropriate use of the device.

The user must observe limits specified in the section technical data for a safe use of the device.

2.3 User Groups

Inappropriate use of the device can lead to damage to persons and to material damage

Requirements on the users:

- Only persons having enough know-how or persons especially instructed are allowed to use the device.
- Users of the device are responsible for their own safety and for the safety of all other persons in proximity of the operated device.
- Users are responsible that all necessary security precautions are taken, especially when lasers are operated with the device.

2.4 Disposal of Device

Electrical devices must be disposed and recycled correctly after the end of usage. The user must return the device to the dealer, importer, or manufacturer or to a recycling company.

2.5 Output Limitation

TEC controllers and laser diode drivers are—depending on the configuration of the LTR-1200—limited in output power if necessary, such that overloading of the internal power supplies is prevented.

The controllers themselves feature a built-in temperature monitoring function, which disables the output when the temperature of the controller gets too high.

3 Functional Description

3.1 Device-specific Documentation

The following devices can be installed into the LTR-1200. Some of these device channels can be connected in parallel to achieve higher output currents. Please contact Meerstetter Engineering if you have requirements which currently are not covered by any of these devices.

LDD-Family (Laser Diode Drivers)

- LDD-1121
- LDD-1124
- LDD-1125

TEC-Family

(Thermo Electric Cooling Controllers)

- TEC-1089
- TEC-1090
- TEC-1091
- TEC-1122
- TEC-1123
- TEC-1161
- TEC-1162
- TEC-1163
- TEC-1166
- TEC-1167

The functional description and the technical data of these devices are documented in their own specific Datasheets and User Manuals.

3.2 Getting Started

The following symbols are used to categorize the steps of the guide:

- ✘ Actions to be performed by the user
- 🔍 Reactions from the soft- or hardware, as indication that an action was successful
- ① Additional background information to the step to be performed

Step	Action	Information/Feedback
1	Hardware Setup	
1.1	✘ Connect the LTR-1200 to the mains power and switch it on.	🔍 The display shows the start screen
1.2	✘ Wait until the LTR-1200 has finished startup.	🔍 The display now shows the main screen ① No error is indicated (both LEDs are green)
1.3	✘ Use the navigation switches to browse through the Menu. The Menu structure is documented in chapter 3.3 Menu Structure	🔍
1.4	✘ Connect to an internal device (choose one of the two options below):	① For more information about how to connect please refer to 3.4 Communication Interfaces)
1.4.1	Ethernet (preferred)	① Simultaneous connections (multiple applications) to several devices are possible. ① Simultaneous connections (multiple PCs) to one device are possible.
1.4.1.1	✘ Set up the IP configuration (See chapter 3.4.2 Connecting LTR-1200 over Ethernet)	
1.4.1.2	✘ Connect the Ethernet cable.	
1.4.2	USB	① Easy on-site connection. ① Only one device at the same time.
1.4.2.1	✘ Connect the USB Cable.	

Step	Action	Information/Feedback
2	Software	
	✘ Connect the corresponding (TEC or LDD) Service Software to a device	① (Notice that you establish a connection to a device. “Device” and “Terminal” have different meanings. See chapter 3.4.1 LTR-1200 Communication)
	✘ Set up the Service Software connection in the Maintenance Tab (See chapter 3.1 Device-specific Documentation)	<p>🔍 When the Software is successfully connected, it will show a green status “Connected” and the Monitor tab will be updated periodically.</p> <p>① If you connect over Ethernet and wish to connect to multiple devices, repeat this procedure for all devices to connect.</p> <p>① Now the device(s) are connected. The device configuration and the various setting options are described in the device-specific User Manuals. (See chapter 3.1 Device-specific Documentation)</p>

3.3 Menu Structure

The Menu is created dynamically depending on the installed devices. Only the Terminals to which a device is connected are shown in the Menu. Each Terminal has its own Menu entry where the most important settings of this Terminal can be adjusted. There is also a small overview for each Terminal.

Because there are so many parameters for each Terminal there is only a small selection of parameters available through the display menu.

Below there is an example of the Menu structure with a TEC controller connected to Terminal 1 and an LDD connected to Terminal 2.

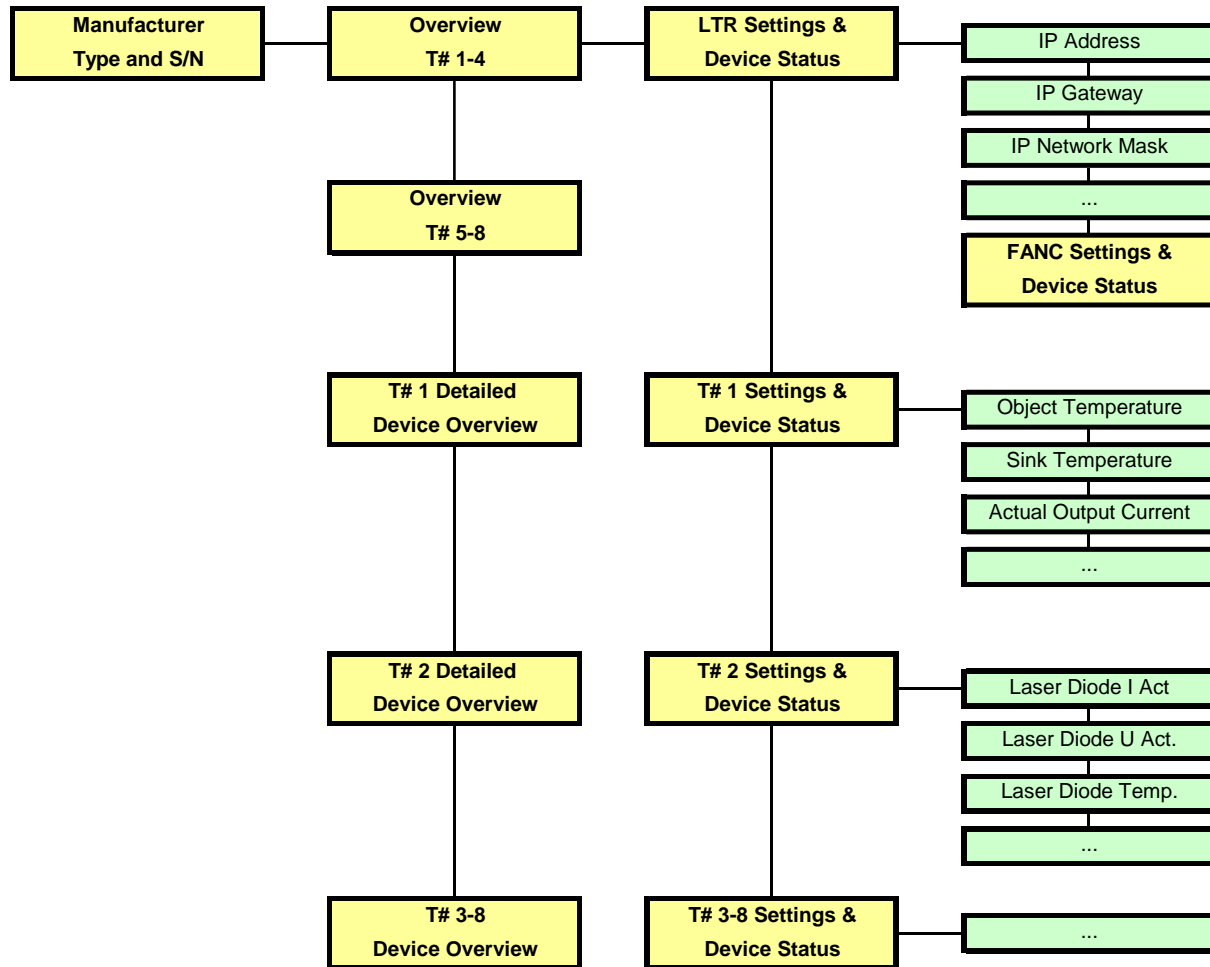

Legend:

T# -> Terminal

Status / Information

Settings

To navigate through the menu use the 5-way navigation switch.

Settings marked with [-/R] have read only permissions.

Settings marked with [R/W] can be modified through the menu. Simply press the OK Button to switch to the editing mode. Use left and right to switch between the digit positions. Use up and down to change the digit's value. Press OK to confirm the setting change.

Errors are shown on the overview screen with a symbol. For a description of the different Symbols see 4.2.1 LCD. A detailed Error Report will be shown on the device specific Menu screen.

3.3.1 Available Device Parameter

Additional Parameters are available on request. Please contact Meerstetter Engineering for an inquiry

3.3.1.1 LTR-1200

- IPv4 Address
- Gateway IPv4 Address
- IPv4 Network Mask
- Service Software Default Device
- Interface RS232 Baud Rate
- Interface RS485 Baud Rate
- HMI Device Address
- Internal Maximal Temperature
- Internal Maximal Fan-Speed

3.3.1.2 LDD

- Laser Diode Current Actual
- Laser Diode Voltage Actual
- Laser Diode Temperature
- Laser Power Actual
- Laser Diode Driver Enable
- Laser Diode Current CW
- Laser Diode Power CW

3.3.1.3 TEC

- Object Temperature
- Sink Temperature
- Actual Output Current
- Actual Output Voltage
- Output Stage Enable
- Target Object Temp

3.4 Communication Interfaces

3.4.1 LTR-1200 Communication Concept

The LTR-1200 is equipped with several communication interfaces, which can be used simultaneously.

Every communication interface has its own receiving buffer.

The router will process every received message. The message is forwarded to the desired device. As soon as the router task has received the responding message from the device, the message is forwarded to the corresponding interface.

Every communication interface has the same priority. All messages are processed successively.

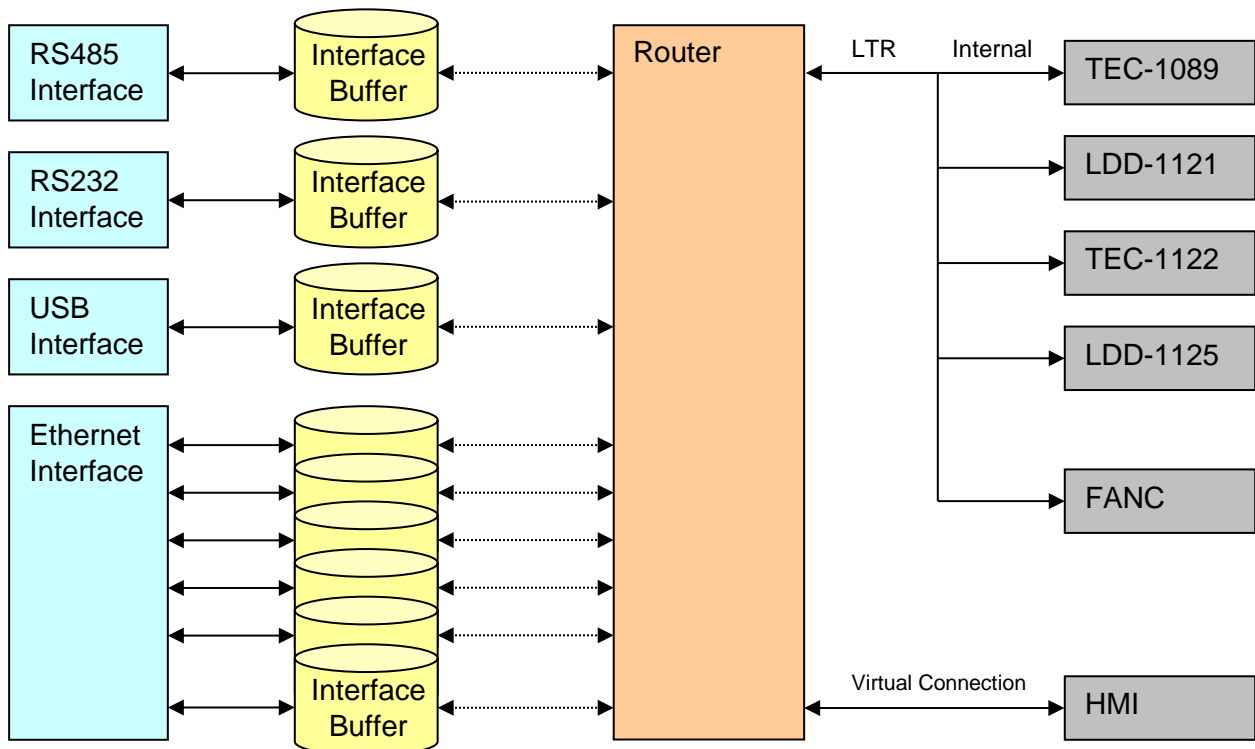

A connection is always between one control software and one device. The Terminal, device number and Channel are not directly associated.

Terminal represents only the output on the backplane of the LTR-1200. One device can be connected to more than one Terminal.

Channel represents the output channel of one device (e.g., CH1 or CH2 in the case of TEC controllers.)

Please consult the “LTR-1200 Configuration Sheet” (which was supplied with the LTR-1200) to find out which device channel is connected to which Terminal.

3.4.2 Maximum Cable Length for RS232, RS485 and I/O

For proper functioning, the maximum cable length for RS232, RS485 and I/O connections is 3.00 m.

3.4.3 Connecting LTR-1200 over Ethernet

The LTR-1200 does not support DHCP. A fixed IP Address configuration must be set over the display menu. Please set the following settings:

- IP Address
- Gateway Address (required for routing)
- Network Mask

Please try to access to the built-in LTR-1200 web server by entering the previously configured IP Address to your web browser.

You can also set the network settings in the HMI Service software (version 1.07 or higher) in the field "Network Settings". Like the following pictures below shows.

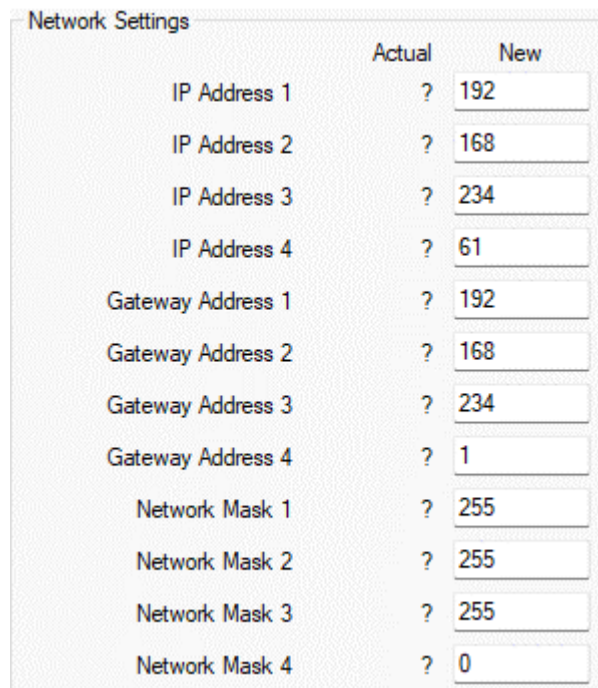

	Actual	New
IP Address 1	?	192
IP Address 2	?	168
IP Address 3	?	234
IP Address 4	?	61
Gateway Address 1	?	192
Gateway Address 2	?	168
Gateway Address 3	?	234
Gateway Address 4	?	1
Network Mask 1	?	255
Network Mask 2	?	255
Network Mask 3	?	255
Network Mask 4	?	0

3.4.3.1 Ethernet Connection

Please refer to 3.1 Device-specific Documentation to connect the Service Software over Ethernet. The Device Address (Device to be addressed) can be found on the LTR-1200 Menu or on the Built-in web site. It usually is the same as the Terminal Number. The LTR-1200 provides a total of six connections (TCP/IP, Port 50000, Timeout: 10s) to control the LDD/TEC Drivers over Ethernet. For Third Party Software communication please refer to the MeCom communication protocol specifications (See chapter 3.1 Device-specific Documentation).

3.4.4 Service Software Default Address

In some cases, it may be helpful to configure a default LDD/TEC driver as standard device. This can be done by setting the 'Service Software Default Device' parameter to a specific LDD/TEC Device Address in the Display menu. In this case the Device Address 0 will be routed to the 'Service Software Default Device'.

3.4.5 Access over Third-Party Software

For Third Party Software communication please refer to the MeCom communication protocol specifications (See chapter 3.1 Device-specific Documentation).

3.4.6 Communication Fault Management

3.4.6.1 For RS485, RS232 and USB Interfaces

A received MeCom-Package with a wrong CRC is not being processed, no error is generated. If a MeCom-Package is being forwarded to a device (LDD/TEC) and no answer is received from the device, no error is generated. The sending host must repeat the MeCom-Package.

3.4.6.2 For Ethernet Interface

A received MeCom-Package with a wrong CRC results in closing the corresponding TCP connection. If a MeCom-Package is being forwarded to a device (LDD/TEC) and no answer is received from the device, the MeCom-Package is being sent to the device two more times. If still no answer is received, the TCP connection is closed by the LTR-1200.

4 Technical Data

4.1 Elements and Configurations

Each rack enclosure is equipped and configured to the customer's specifications:

- Up to four LDD-Family or TEC-Family devices can be built in (See 5 Quotation Request Form).
- The number of required power supplies and fans depends on types, numbers, and applications of the built-in devices. Meerstetter Engineering equips the LTR-1200 accordingly.
- The LTR-1200 is back panel configurable, the standard panel offers 4 power output terminals and 4 sensors inputs connectors. (Up to 8 Terminals are possible)
- It is also possible to install third party devices. Please contact Meerstetter Engineering with your enquiry.
- Important note concerning the integration of LDD-Family devices into LTR-1200 rack enclosures: The internal wiring from an LDD device to its back panel terminal can measure several 10cm and represents an inductive load. Therefore, fast pulsing performance will be impaired.

4.2 Front Panel

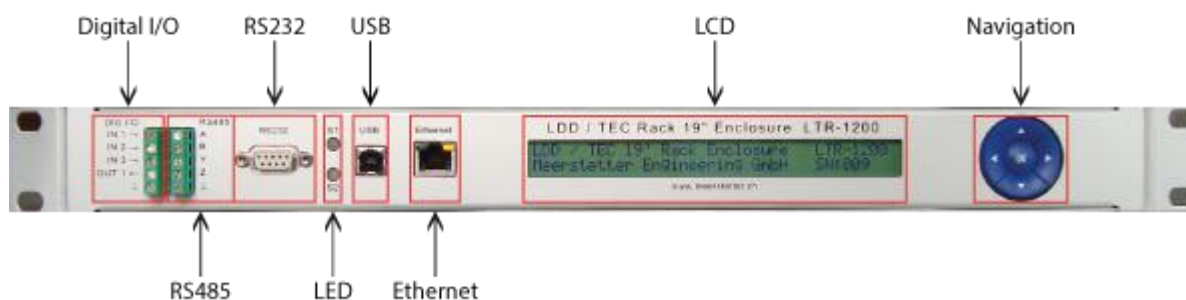

4.2.1 LCD



The picture shows the LCD display of an LTR-1200 with 4 devices built-in.

Symbols on the LCD Display				
	⚪	⌘	✓	×
First Symbol (Next to TEC/LDD)	Device is 'Ready'	Other (Reset, Restart, Bootloader, ...)	Device is 'Run- ning'	Device has an Error
Second Symbol (if type is TEC)	Not in Temperature Control Mode	'Wait' (not stable, yet)	Stability Reached	-

4.2.2 Navigation

There is a five-point navigation switch available to browse through the Menu. This can be used to change the most important settings of the internal devices.

4.2.3 LED

Dual Color Status LEDs	
LED	Sources (grouped)
S1 (top)	LTR Components (HMI, Fan Controller)
S2 (bottom)	Built-in Devices (LDDs, TECs)

Grouped status code is prioritized, i.e., if one output stage is running, the grouped LED shows 'Run', if one device has an error, the grouped LED shows 'Error'.

LED Status Description (S1, S2)		
Color	Pattern	Signification
Green	Slowly blinking	'Ready' status (no Error)
Green	Blinking fast	'Run' status (no Error)
Red	Static on	'Error' status, output stages disabled
Red	Slowly blinking	Unknown Device Status, but no Error

4.2.4 Digital I/O

4.2.4.1 Pinout

Type	DIG IO Label	LDD-112x	TEC-1122/1123	TEC-1089/1090	LTR-1200
Input 1	IN1 →	RES8	GPIO8	GPIO1	Special Function available on request
Input 2	IN2 →	RES7	GPIO7	GPIO2	
Input 3	IN3 →	RES6	GPIO6	GPIO3	
Output 1	OUT ←	RES5	GPIO5	GPIO4	
GND	⊥	Digital IO Ground			



All digital I/Os are ESD-protected and have a series and pull-down resistor.

4.2.4.2 Characteristics

Symbol	Parameter	Comments	Min	Typ	Max	Units
Digital Isolator Characteristics						
f_{TRANSFER}	Transfer Frequency	NRZ (No Return to Zero)	0		25	MHz
$t_{\text{PHL}}, t_{\text{PLH}}$	Propagation Delay			45	60	ns
Input Characteristics (Digital Isolator)						
V_{IH}	Logic High Input Threshold		2.31			V
V_{IL}	Logic Low Input Threshold				0.99	V
V_{IMAX}	Max Input Voltage		-0.5		5.5	V
Output Characteristics (Digital Isolator)						
V_{OH}	Logic High Output Voltage	Output Current 20uA	3	3.3		V
V_{OL}	Logic Low Output Voltage	Input Current 20uA		0	0.1	V
V_{OHL}	Logic High Output Voltage (Hi Load)	Output Current 4mA	2.8	3.1		V
V_{OLL}	Logic Low Output Voltage (Hi Load)	Input Current 4mA		0	0.4	V
ESD Protection (between Digital Isolator and Connector)						
V_{PP}	ESD Discharge	IEC61000-4-2			100	kV
R_{A}	Series Resistance		170	200	230	Ω

4.2.5 RS485

4.2.5.1 Pinout

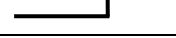
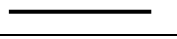
RS485 Label	Half-Duplex Connection	
A		A
B		B
Y		
Z		
\perp		GND

4.2.5.2 Characteristic

Symbol	Parameter	Comments	Min	Typ	Max	Units
Digital Isolator Characteristics						
Speed	Communication Speed (Baud Rate)	Software Setting	4800		1M	bps
VPP	ESD Protection	Human Body Model			+/-15	kV
Input Characteristics (Receiver)						
VTH	Differential Input Threshold Voltage		-200	-125	-30	mV
VHYS	Input Voltage Hysteresis			15		mV
RIN	Line Input Resistance		96			kΩ
Output Characteristics (Driver)						
VOD1	Differential Output Voltage, Loaded	RL = 100Ω (RS422)	2.0		3.6	V
VOD2	Differential Output Voltage, Loaded	RL = 54Ω (RS485)	1.5		3.6	V

4.2.6 RS232

4.2.6.1 Pinout

Pin	Function
2	TxD (Data from LTR)
3	RxD (Data to LTR)
5	Signal Ground (GND)
other	Not Connected

4.2.6.2 Characteristic

Symbol	Parameter	Comments	Min	Typ	Max	Units
Protection Characteristics						
VPP	ESD Protection	Human Body Model			+/-15	kV
Electrical Characteristics						
Speed	Communication Speed (Baud Rate)	Software Setting	4800		1M	bps
VOH	High-level Output Voltage	TxD at RL = 3kΩ to GND	5	5.5		V
VOL	Low-level Output voltage	TxD at RL = 3kΩ to GND	-5	-5.4		V
VIT+	Positive Input Threshold Voltage			1.5	2.4	V
VIT-	Negative Input Threshold Voltage		0.6	1.2		V

4.2.7 USB

The USB interface is electrically isolated. A virtual COM Port is provided for communication with a host PC. The drivers are the same as the ones already required / installed for the individual internal devices. (Used chip: FTDI FT232RQ)

4.2.7.1 Characteristic

Symbol	Parameter	Comments	Min	Typ	Max	Units
Protection Characteristics						
VISO	Isolation Voltage		1	-	2.5	kV
VPP	ESD Protection	Human Body Model			+/-15	kV
Electrical Characteristics						
Speed	Communication Speed (Baud Rate)	Software Setting	4800		1M	bps

4.2.8 Ethernet

4.2.8.1 Specifications

The Ethernet meets the following specifications:

- IEEE 802.3 compliance
- 100BASE-TX and 10BASE-T compliance
- Auto Negotiation (Automatically switch between 10Mbit/s / 100Mbit/s, Half -/ Full-Duplex)
- Auto MDIX (Auto crossover)
- Optional VLAN (available on request)
- Optional IEEE 1588: Precision Time Protocol (available on request)

4.2.8.2 LED Description

	Green	Orange
Off	Not connected	10Mbit/s
Blink	Activity	-
On	Connected	100Mbit/s

4.2.8.3 Available Features

- Small embedded website
- Service Software communication
- MeCom protocol

4.3 Back Panel



Picture of 4 Terminal Version. (Only approx., the sensor connectors are wrong)



Picture of the 8 Terminal Version

By standard, the GND potentials of all built-in TEC and LDD devices are interconnected. Consequently, all external loads and sensors to be attached to the back panel should be potential-free. At the most, only one single potential (e.g. GND of one laser diode) may be tied to a given potential; it is however recommended to keep all loads and sensors potential-free.

Upon customer request, individual outputs can be equipped such that they are potential-free (i.e. independent of other built-in devices). Please contact Meerstetter Engineering with your enquiry

4.3.1 TEC Sensors Pinout

Fully pre-confectioned cables are available from Meerstetter Engineering at request.

4.3.1.1 Part List

Description	Manufacturer	Manufacturer Part Nr.
Connector Solder 7-Way	Binder	99-4925-00-07
Cable 6-Way, Shielded	Kabeltronik	2-LifYCY TP (820600800)

4.3.1.2 Pinout

Function	Pin	Cable Color
Object Voltage Sense +	1	White
Object Voltage Sense -	2	Brown
Object Current Output	3	Green
Object Current Return	4	Yellow
Sink Sense A	5	Grey
Sink Sense B	6	Pink
NC	7	-

Please connect “Current Output” and “Voltage Sense +” together to one side of the thermistor/RTD,

and “Current Return” and “Voltage Sense –” together to the other side of the thermistor/RTD.

4.3.2 LDD Sensors Pinout

Fully pre-confectioned cables are available from Meerstetter Engineering at request.

4.3.2.1 Part List

Description	Manufacturer	Manufacturer Part Nr.
Connector Solder 4-Way	Binder	99-4909-00-04
Cable 4-Way, Shielded	Kabeltronik	2-LifYCY TP (820400800)

4.3.2.2 Pinout

Function	Pin	Cable Color
Temperature Sense A	1	White
Temperature Sense B	2	Brown
Photodiode Cathode	3	Green
Photodiode Anode	4	Yellow

4.3.3 AC Mains Supply

The main power connector is a 3-pol Connector for IEC C13 Cables

Symbol	Parameter	Comments	Min	Typ	Max	Units
Electrical Characteristics						
V _{ACnom}	Nominal Input Voltage	Single Phase	100		240	V
V _{AC}	Input Voltage	Continuous	90		264	V
V _{ACtrans}	Input Transients	60ms			300	V
f _{AC}	Input Frequency		47	50/60	63	Hz
P _{IN}	Input Power*	1 - 4 Power Supplies	400		1600*	W
P _{IN110}	Input Power (110V _{AC})	1 - 4 Power Supplies	400		1100	W
Protection Characteristics						
Fuse	Slow Fuse	Integrated into Connector		10		A

* When operated on 110V_{AC} mains supply, the max input power is derated to 1100W due to the 10A fuse built into the standard IEC C13 housing. Please contact Meerstetter Engineering if you require an alternative connector.

4.4 Error Numbers

Error Numbers 1 to 99 are universal error numbers, which are identically on each device. For all other universal error numbers please refer to the LDD-Family or TEC-Family User Manuals. Error Numbers 100 and above are HMI (LTR)-specific.

4.4.1 RTOS Errors

#	Code	Description	Error Condition, Remedy
80	RTOS_STACKOVERFLOW	One task has a stack overflow	Please contact Meerstetter Engineering
81	RTOS_MALLOCFAIL	Cannot allocate memory	Please contact Meerstetter Engineering

4.4.2 Routing Errors

#	Code	Description	Error Condition, Remedy
100	ROUTING_LOSTFRAME	The routing task has lost a frame	Lost frame on internal bus
101	COM_TIMEOUT	Communication timeout to an internal device occurred	No answer for 3x100 ms
102	ADDRESS_CONFLICT	Two internal devices use the same address on the bus	Two identically addresses detected

4.4.3 HMI Errors

#	Code	Description	Error Condition, Remedy
110	DEVICE_VERSION	HMI and device firmware versions not compatible	Update all device firmware to the actual version.
111	DEVICE_MISSING	Unassigned rack output terminal detected	Try to reboot the LTR-1200
112	MENU_OVERFLOW	Menu memory overflow	Please contact Meerstetter Engineering
113	UNKNOWN_DEVICE	Unknown internal device recognized	Please contact Meerstetter Engineering

4.5 Physical Dimensions

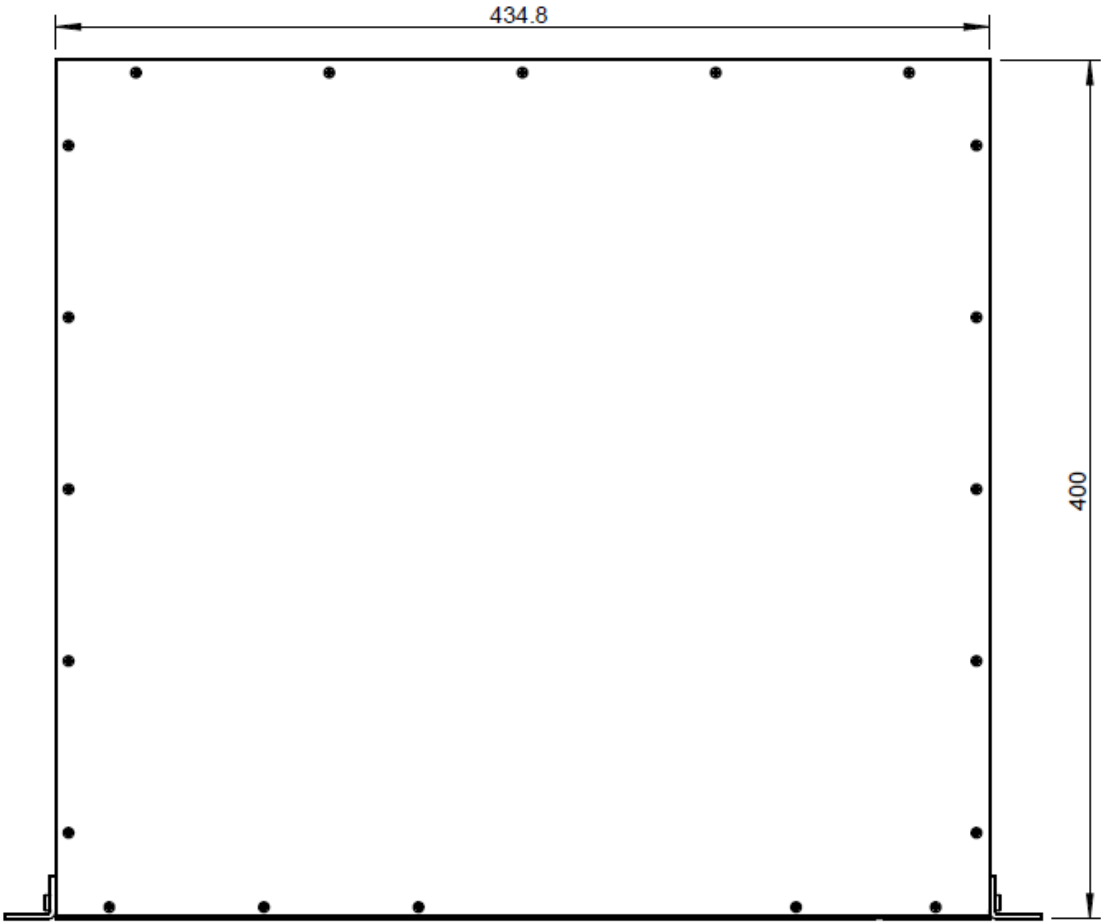
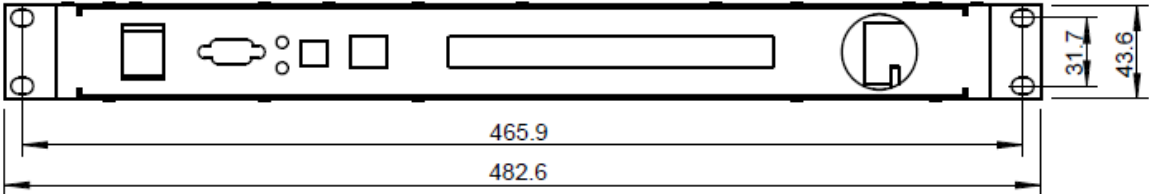

All dimensions are in mm

Rack mounting brackets are removable

4.6 License Notice

The LTR-1200 Software is built on FreeRTOS (<http://www.freertos.org>).

A Change History

Date of change	Doc/Version	Changed/Approved	Change / Reason
12 Feb 2019	D		<ul style="list-style-type: none">• Various format changes• SWISS MADE replaced by Developed, assembled in Switzerland• Add specs: Humidity and IP Code• Add: Safety Information• Add: Maximum cable length information• Mod: RES signals renamed to GPIO
18 Nov 2020	D	ML	<ul style="list-style-type: none">• Add: Change history
27 Jan 2023	D	RS / LS	<ul style="list-style-type: none">• Fix formatting and index• Remove misleading isolation rating of digital isolator ICs
30 Jan 2023	D	LS /RS	<ul style="list-style-type: none">• Replace old Logo
01 Feb 2023	D	LS / RS	<ul style="list-style-type: none">• Delete Chapter 5• Transferred to new template
16 May 2025	E	NZ / ML	<ul style="list-style-type: none">• Added TEC- 1091, 1162, 1163, 1166, 1167• Added the text about the Network Settings, which are now available for the user.