

Miniature OEM TEC Controller

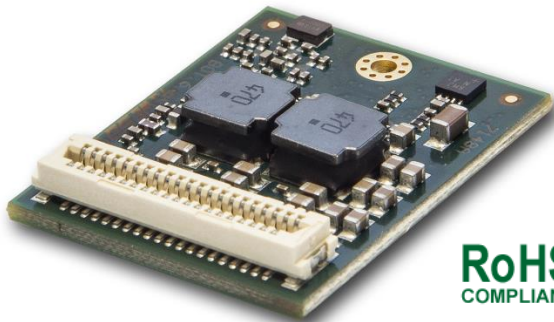

General Description:

The TEC-1092 is a very small, PCB mountable Peltier Controller module, especially designed to meet the requirements for small thermoelectric applications.

Product Highlights:

- High current resolution
- Temperature control rate from 1 Hz to 90 Hz
- Very small dimensions
- High efficient TEC Controller (DC output)

Applications:

- Telecom grade TEC modules
- Cooling of thermally fast objects
- Infrared detectors / sensors
- Gas sensor applications



- TEC-1092 can be mounted on the EVL-1093 Evaluation Board (See page 5 for more information)

Features

Input Characteristics:

- DC Input Voltage: 5 to 12 V

Output Stage TEC Controller:

- Voltage: 0 to ± 9.6 V
- Current: 0 to ± 1.2 A

Main Features:

- Print mountable TEC Controller
- Temperature Sensor Types: Pt100, Pt1000, NTC, Voltage
- Temperature Precision / Stability: <0.01 °C
- Temperature Control & Measurement Frequency: 1 Hz, 10 Hz, 90 Hz
- No cooling required (natural convection)
- Communication bus compatible
- Configuration and monitoring with Service Software

Operation Modes:

- Stand-alone operation
- Remote-controlled over RS232 TTL, RS485, I/O
- Script-controlled over lookup table (thermal cycling)

Driver Modes:

- DC power supply (bipolar)
- Temperature control: PID settings, auto tuning, optional cool/heat-only or resistor heating modes

Data Interfaces:

- RS232 TTL
- RS485

General Purpose I/O Features:

- Configurable as input to control TEC-1092 (Enable, Temperature up / down etc.)
- Configurable as output to monitor TEC-1092 (Error Indication, Temperature Stable Indication etc.)

Special Requirements / More Information:

- Please contact us for additional information or customization.

Absolute Maximum Ratings

Supply voltage (DC)	20 V
---------------------	------

Operating Ratings

Temperature	-40 – 90°C
Humidity	5 – 95%, non-condensing

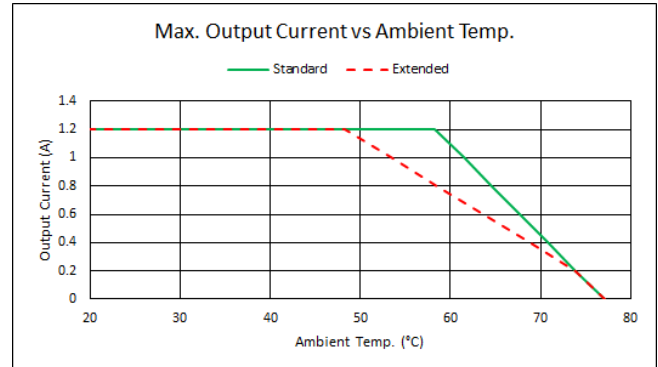
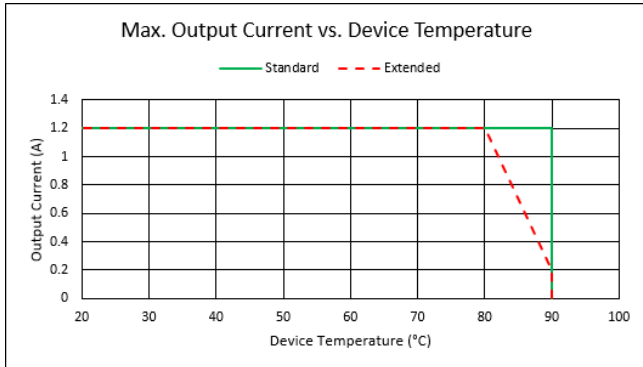

Standard or Extended Device Temperature Mode can be set as software setting.

The right Diagram shows the situation with an external 7.5Ω resistor. TEC Controller mounted on the EVL-1093 and supplied with 12V. No forced air flow was present.

Electrical Characteristics

Unless otherwise noted: $T_A = 25\text{ °C}$, $U_{IN} = 12\text{ V}$, $R_{load} = 7.5\text{ }\Omega$

Symbol	Parameter	Test Conditions	Min	Typ	Max	Units
DC Power Supply Input:						
U_{IN}	Supply voltage		4.9		12.5	V
Output:						
I_{OUT}	Bipolar current swing				±1.2	A
U_{OUT}	Bipolar voltage swing				±9.6	V
U_{OUT} Ripple	Voltage ripple	@ 1.2 A		25		mV _{PP}
I_{OUT} Drift	Output current temperature drift			0.1		mA/°C
System Characteristics:						
$\eta_{50\%}$	Power efficiency	@ 50% load		85		%
$\eta_{90\%}$	Power efficiency	@ 90% load		88		%
Output Monitoring (I_{OUT} resolution is 732µA; U_{OUT} resolution is 4.15 mV)						
I_{OUT} Read	Precision	@ 1.2 A		1	5	%
U_{OUT} Read	Precision	@ 9.6 V		1	3	%

Output Safety Characteristics

Unless otherwise noted: $T_A = 25\text{ °C}$, $U_{IN} = 12\text{ V}$

Symbol	Parameter	Test Conditions / Hints	Min	Typ	Max	Units
Output Stage Protection Delays:						
t_{OFF} Short circuit		Full load condition		10	30	µs
t_{OFF} Power system limits		Current and voltage limits			200	µs
Output Stage Current Supervision: (If the $OUT+$ and $OUT-$ currents differ too much, an error is generated)						
I_{OUT_DIFF}	Error threshold			120		mA

Object Temperature Measurement Characteristics (NTC Probes)

NTC thermistor resistive input characteristics translate into temperature ranges valid for only one type of NTC probe. Below example is given in the case of an NTC B_{25/100} 3988K R₂₅ 10k temperature sensor.

Symbol	Parameter	Test Conditions / Hints	Min	Typ	Max	Units
R _{OBJ, RANGE}	ADC Auto Gain PGA = 1 or 8 or 32	Very Low-°T Configuration NTC Corresponding temperature range	73		1M	Ω °C
				194.3 to -55.5		

R_{OBJ, RANGE} is resistance range of the NTC sensor

Object Temperature Measurement Characteristics (Pt100 and Pt1000 Probes)

Measurement configuration = 23 bit / 4-wire / unshielded cable <50 mm

Symbol	Parameter	Test Conditions / Hints	Min	Typ	Max	Units
T _{OBJ, RANGE}	Range	Range is extendable upon request Default measurement range is -220°C ... +200°C Extended measurement range is -193°C ... +787°C	-100		+200	°C
T _{OBJ, PREC}	Precision	(EN 60751 / IEC 751)		0.005	0.01	°C
T _{OBJ, COEFF}	Temp. Coefficient	Relative to device temperature			1.6m	°C/K
T _{OBJ, NOISE}	Value Noise	Reference measurement fluctuations while output stage operating @70% load		0.003		°C
T _{OBJ, REP}	Repeatability	Repeated measurements of reference resistors after up to 3 days		0.005		°C

Object Temperature Monitoring Configuration (Voltage Measurement VIN1)

Sensors with linear Voltage/Temperature output.

Symbol	Parameter	Test Conditions / Hints	Min	Typ	Max	Units
V _{SENS, DIFF}	Range	Differential Input voltage Temperature range depends on sensor used	-2.039		2.039	V
V _{OBJUX, ABS}	Range	Absolute Input voltage	-0.1		5.1	V

Heatsink Temperature Measurement Characteristics (NTC only)

T_A = 25 °C, measurement configuration = 12 bit / 2-wire / unshielded cable <50 mm, °T probe = NTC B_{25/100} 3988K R₂₅ 10k

Symbol	Parameter	Test Conditions / Hints	Min	Typ	Max	Units
R _{SINK, RANGE}	Range	Corresponding temperature range	180		44600	Ω °C
				150 to -6.0		

RS232 TTL and General Purpose Digital I/O Characteristics (GPIO1 ... GPIO8, RX, TX)

Unless otherwise noted: T_A = 25°C, U_{IN} = 12 V

Symbol	Parameter	Test Conditions	Min	Typ	Max	Units
Input Characteristics:						
U _{IH}	Logic high input threshold		2.38			V
U _{IL}	Logic low input threshold				0.93	V
U _{IMAX}	Maximum input voltage		-0.5		5.5	V
Output Characteristics:						
(Microprocessor)						
U _{OH}	Logic high output voltage	Output current 8mA	2.8			V
U _{OL}	Logic low output voltage	Input current 8mA			0.4	V

Pin Configuration and Mechanical Data

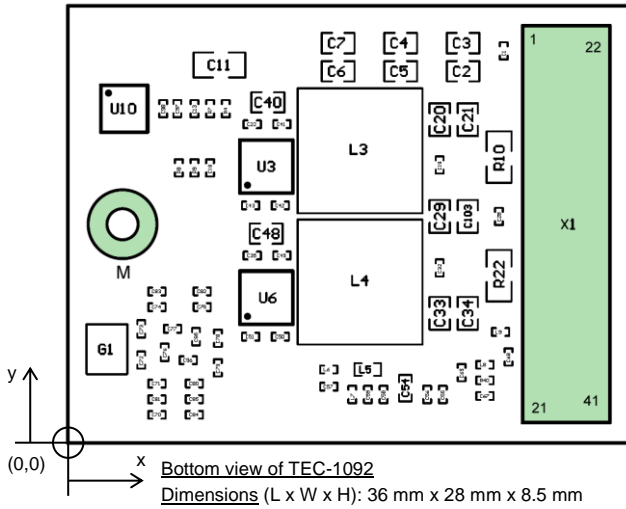

- For direct PCB mounting: The PCB should be mounted at the mounting bore M using an M2 screw
Receptacle height when mated: 5.00 mm
- X1 connector type: Amphenol FCI, 41 Position Connector Receptacle, manufacturer P/N 91930-21141LF, Digi-Key P/N 609-1594-ND
- Mating connector type: Amphenol FCI, 41 Position Connector Header, manufacturer P/N 91911-31341LF, Digi-Key P/N 609-3427-1-ND
- PCB SMD threaded standoff (for bore hole M on host PCB): Würth Electronics, M2, manufacturer P/N 9774050243R, Digi-Key P/N 732-7097-1-ND

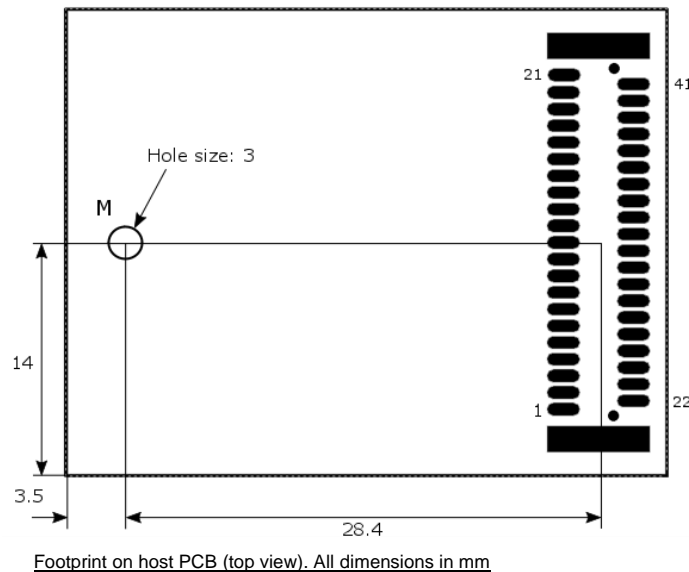

Pin Description X1:

1	VDD	OUT+	8
2	VDD	OUT+	9
3	VDD	OUT+	10
4	GND	OUT-	11
5	GND	OUT-	12
6	GND	OUT-	13
7	GND		
		SHILED	14
		OBJECT_IA	15
		OBJECT_IB	16
		OBJECT_UA	17
		OBJECT_UB	18
		SINK_B	19
		SINK_A	20
		NJTRST	36
		JTDO	35
		JTCK	38
		JTMS	39
		JTDI	37
		NRST	40
		NC	41
		MOUNTING	M
21	RS232_RX		
22	RS232_TX		
23	RS485_A		
24	RS485_B		
25	GPIO1		
26	GPIO2		
27	GPIO3		
28	GPIO4		
29	GPIO5		
30	GPIO6		
31	GPIO7		
32	GPIO8		
33	3.3V		
34	5V		

- Pin 35-40: JTAG programming signals (do not connect) or may be used for DPY-1113.
- Pin 33 (3.3V) outputs up to 200mA for external loads
- Pin 34 (5V) outputs up to 100mA for external loads

TEC Board X1

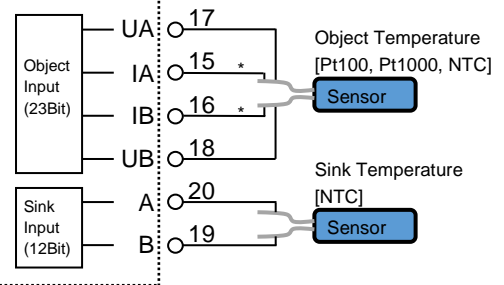

* The TEC-1092 uses always 4 wires to sense the object temperature. There are no bridge jumpers on board. For NTC, please make a bridge on the mother board close by the X1 connector.

Operation-Modes / Theory of Operation

The TEC-1092 is an OEM precision TEC Controller that is primarily designed as a PCB mountable device. However, the TEC-1092 can be mounted on the EVL-1093 Evaluation Board. This allows the connection to a host by USB and usage of a DPY-1113 TEC Status Display Kit.



Status information can be polled at any time by industry-standard RS485 / RS232 TTL connection or by USB (see box below). The TEC-1092 can also operate in a remotely-controlled manner, with parameters adjusted on the fly. The latest firmware upgrade introduced scripting capability by sequential lookup table read-out.

Configured as a DC power-supply, the TEC-1092 can handle current and voltage settings. In the remote-control case, temperature data may be passed on to be processed by the host.

Configurable parameters further include: sensor linearization (Pt100 / Pt1000) and Steinhart-Hart modeling (NTC), temperature acquisition hardware calibration, Peltier element modeling, PID controller auto tuning, nominal temperature ramping, current, voltage and temperature limits, error thresholds, etc. Please refer to the TEC Controller User Manual (Document 5216) for further information.

TEC Service Software

The screenshot shows the main interface of the TEC Service Software. It features several panels for monitoring and control:

- CH1 Temperature Measurement:** Object Temperature [°C] 25.074, Sink Temperature [°C] 25.000.
- CH2 Temperature Measurement:** Object Temperature [°C] NA, Sink Temperature [°C] NA.
- CH1 Temperature Control:** Target Object Temperature [°C] 18.000, (Ramp) Nominal Object Temperature [°C] 18.000, Thermal Power Model Current [A] 0.00.
- CH2 Temperature Control:** Target Object Temperature [°C] 0.000, (Ramp) Nominal Temperature [°C] 0.000, Thermal Power Model Current [A] 0.00.
- CH1 Output Stage Monitoring:** Actual Output Current [A] 0.01, Actual Output Voltage [V] 0.01.
- CH2 Output Stage Monitoring:** Actual Output Current [A] 0.00, Actual Output Voltage [V] 0.00.
- CH1 FAN Controller:** Relative Cooling Power [%] 0, Actual FAN Speed [rpm] 0.
- CH2 FAN Controller:** Relative Cooling Power [%] 0, Actual FAN Speed [rpm] 0.
- CH1 Temperature Controller PID Status:** PID Upper Limitation [%] 0.0, PID Lower Limitation [%] 0.0, PID Control Variable [%] 0.0.
- CH2 Temperature Controller PID Status:** PID Upper Limitation [%] 0.0, PID Lower Limitation [%] 0.0, PID Control Variable [%] 0.0.
- CH1 Temperature Measurement (Sensors):** Object Sensor Raw ADC Value [.] 4910738, Object Differential Voltage [V] NA, Object Sensor Resistance [Ω] 109.764, Object Sensor Temperature [°C] 25.074, Sink Sensor Raw ADC Value [.] 2850, Sink Sensor Resistance [Ω] 9642, Sink Sensor Temperature [°C] 25.834.
- CH2 Temperature Measurement (Sensors):** Object Sensor Raw ADC Value [.] 0, Object Differential Voltage [V] 0.000, Object Sensor Resistance [Ω] NA, Object Sensor Temperature [°C] NA, Sink Sensor Raw ADC Value [.] 0, Sink Sensor Resistance [Ω] 0, Sink Sensor Temperature [°C] NA.
- Firmware and Hardware Versions:** Device Type [.] 1089, Firmware Version [.] 3.11, Firmware Build Number [.] 514, Hardware Version [.] 1.71, Serial Number [.] 4439.
- Power Supplies and Temperature:** Driver Input Voltage [V] 24.26, Medium Internal Supply [V] 8.55, 3.3V Internal Supply [V] 3.30, Device Temperature [°C] 27.3.
- Device Temperature Mode (Standard or Extended):** Maximum Device Temperature [°C] 60.0, Maximum Output Current [A] 10.0.
- Output Stage Monitoring:** Actual Output Current (CH1 + CH2) [A] 0.01.
- Error Status:** Error Number [.] 0, Error Instance [.] 0, Error Parameter [.] 0, Error Description: No Error.

At the bottom, there is a status bar showing "Connected" and "Device Status: Ready". It also includes fields for "Login" and "Logout" with values for CH1 (25.074 °C, 0.01 A, 0.01 V) and CH2 (NA °C, 0.00 A, 0.00 V). Buttons for "Import Config", "Read Config", "Reset TEC", "Export Config", and "Write Config" are visible.

Features:

- Operation control, monitoring and data logging
- Limits and error management
- Charting functions for TEC Controller
- Auto tuning of PID values
- Firmware upgrades
- Included in the price of the TEC Controller

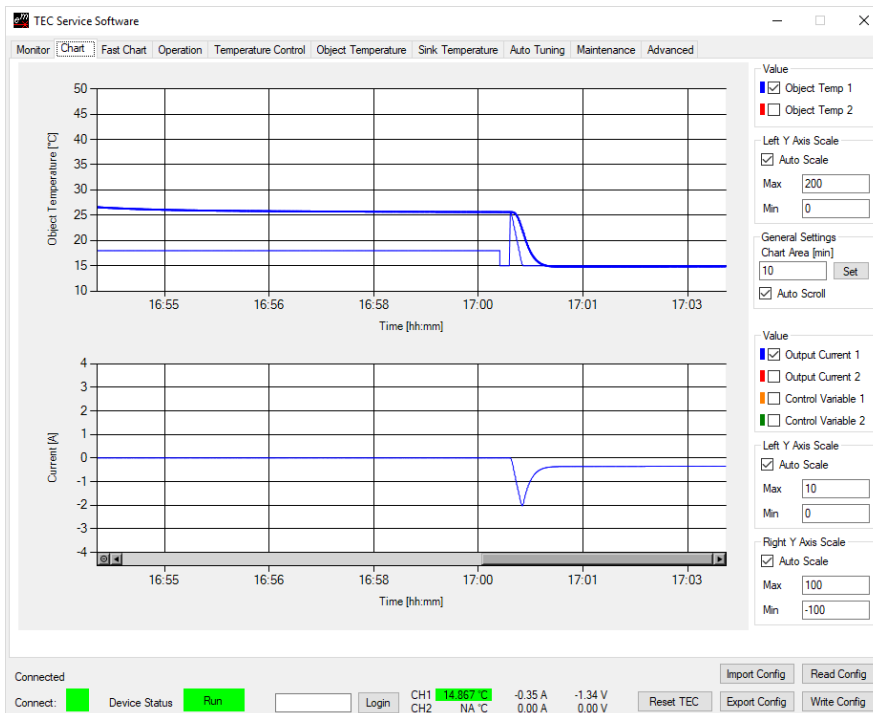

Charting functions in the service software

TEC-1092 Ordering Information, Hardware Configuration

Example Configuration: **TEC-1092-PT100**

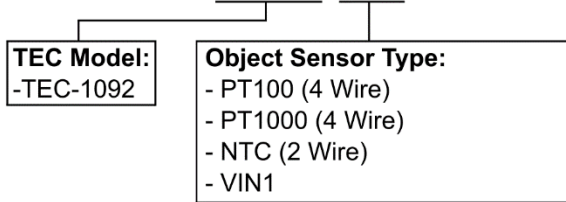

Object Object Sensor Type:

Thermocouple: To use our TEC Controller with thermocouples type K, you need a TCI-1181 in addition to the TEC Controller with a VIN1 Object Sensor Type configuration.

Customization:

Many hardware and software features of the TEC-1092 are customizable upon request. Please contact Meerstetter Engineering with your enquiry.