

Advanced OEM Laser Diode Driver with Laser Power Control [LPC optional]



Features

DC Input Voltage:	12-24 V
Output Current:	0-30 A, <2% Ripple
Output Voltage:	0-15 V (max. VIN - 8 V)
CW / Modulated Current:	
- CW Current Control	Configurable PID
- CW Current Resolution	2 mA
- CW Current Modulation	3 kHz (0.2 A/μs @ 10-30 A)
Pulsed Current:	
- Pulse Generation	CW Chopping
- Pulse Rise / Fall Time	<200 ns (L _{Load} < 100 nH)
- Pulse Frequency	up to 100 kHz
- Pulse Duty Cycle	0 to 100%
Laser Power Control (LPC):	[optional]
- CW Light Control	Configurable PID
- Light Meas. Resolution	<1% Full Power
- Light Meas. Sampling	1 MHz
Error Handling	Ultra-Fast Switch-off (<4 μs) for optimal LD protection
Configuration / Diagnosis:	on PC (via USB / RS485)
Dimensions (L x W x H):	120 mm x 90 mm x 18 mm
Efficiency:	>94% (@ >50% Load)
Cooling:	over Base Plate

Control Modes and Interfaces

Control Modes:	
- Data (USB or RS485)	Full Control
- Internal Generators	Currents, Light and Timing
- Hardware Lines	Nominal Current, Pulse
Interfaces:	
	1x Isolated USB 2.0
	1x RS485 / RS422
	1x Analogue Input
	- Nominal Current
	2x Digital I/O (3.3 V / 5 V)
	- Pulse
	- Interlock (Enable)
	6x Reserve I/O

General Description

The LDD-1125 is an innovative laser diode driver that contains a specialized current source able to precision-drive laser diodes in continuous / modulated and pulsed operation. Equipped with optional light measurement circuitry (photodiode input), the LDD-1125-LPC can also be operated as a Laser Power Controller.

Core element of the LDD's internal current source is the generation of highly precise 333 ps timing steps that results in 2 mA resolution and very low ripple.

The output is short-circuit safe and can be modulated and chopped for up to 100 kHz pulsed-mode operation. Driving low inductive loads, fall and rise times better than 200 ns are achieved.

For ultimate laser diode protection the supervision of critical system values is directly implemented in hardware. This results in very fast switch-off times (<4 μs) in case of limit value violation. The LDD-1125 also monitors laser diode temperature (NTC thermistor input).

The LDD-1125 is fully digitally controlled; its firmware is upgradeable to offer various communication options and to meet specific customer requirements.

Current, light [optional] and temperature measurement hardware can be calibrated.

For basic applications or device evaluation, only a power supply and a laser diode need to be connected to the LDD-1125. The device can operate stand-alone in current control mode, internal generators (on board) allow for parametric definition of flexible output waveforms.

The included PC-Software (USB / RS485) facilitates configuration, control, monitoring and live diagnosis of the LDD. Current and light power [optional] charting is also available from within the software.

All device settings are saved in non-volatile memory and can be backed up and restored.

For remote / OEM applications, the LDD-1125 may be fully controlled by a system bus that features RS485 communication, pulse, interlock and 6 reserve lines.

The LDD-1125 is part of the LDD-Family of Meerstetter laser diode drivers. It is designed to operate alongside TEC-1122-based dual TEC controllers. Both families of devices share the same system bus as well as other characteristics such as design, technology and physical dimensions.

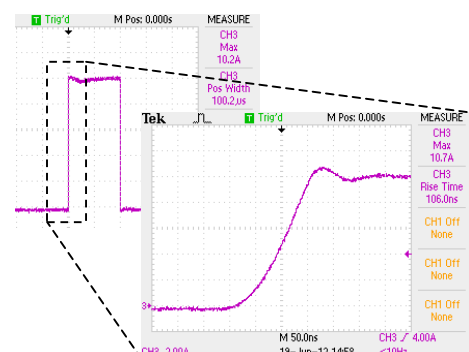

Absolute Maximum Ratings	
Supply voltage (DC)	26.5 V
Supply current (DC)	22 A
Output current	30 A
Output voltage	V_{IN}

Operating Ratings	
System base plate	< 50 °C
Operation temperature	0 – 60 °C
Storage	-30 – 70 °C
Humidity	5 – 95%, non-condensing

Electrical Characteristics

Unless otherwise noted: $T_A = 25\text{ °C}$, $V_{IN} = 24\text{ V}$, $V_{LD} = 10\text{ V}$

Symbol	Parameter	Conditions	Min	Typ	Max	Units
DC Power Supply Input:						
V_{IN}	Supply voltage		11.5	24	26.5	V
V_{IN} Trans.	Overvoltage tolerance	Transients		28.2		V
V_{IN} Ripple	Ripple tolerance		300			mV _{PP}
System Characteristics:						
$\eta_{50\%}$	Power efficiency	@ 50% load		95		%
$\eta_{90\%}$	Power efficiency	@ 90% load		93		%

Output Characteristics

Unless otherwise noted: $T_A = 25\text{ °C}$, $V_{IN} = 24\text{ V}$, $V_{LD} = 10\text{ V}$

Symbol	Parameter	Conditions	Min	Typ	Max	Units
Output CW:						
I_{OUT}	Current range		0		30	A
I_{OUT}	Current resolution	$I_{out} > 2A$		2		mA
I_{OUT}	Current ripple	$I_{out} > 2A$			50	mA
V_{OUT}	Diode voltage		0		15	V
V_{OUT}	Output voltage				$V_{IN} - 8$	V
P_{OUT}	Output power				450	W
f_{CW}	Current change	For $L_{Load} < 100\text{ nH}$, higher f_{CW} are possible		3		kHz
I_{OUT}	Current slope limit	$I_{out} > 10A$		0.1		A/us
Output Pulse:						
t_{rise}	Current rise time	$L_{Load} < 100\text{ nH}$		150		ns
t_{fall}	Current fall time	$L_{Load} < 100\text{ nH}$		150		ns
t_{delay}	Delay pulse/current	$L_{Load} < 100\text{ nH}$		800		ns
f_{Pulse}	Pulse frequency	For $L_{Load} < 100\text{ nH}$, higher f_{Pulse} are possible		100		kHz

Safety Characteristics

Unless otherwise noted: $T_A = 25\text{ °C}$, $V_{IN} = 24\text{ V}$, $V_{LD} = 10\text{ V}$

Symbol	Parameter	Conditions	Min	Typ	Max	Units
Protection Delays:						
t_{OFF}	Overcurrent			3	4	μs
t_{OFF}	Operating Values	Voltages, currents		100		μs
t_{OFF}	System failure	System status		100		ms

Input Characteristics

Symbol	Parameter	Conditions	Min	Typ	Max	Units
I/O Ports						
V_{IL}	Input low voltage	Digital inputs			0.7	V
V_{IH}	Input high voltage	Digital inputs	2.4	3.3	5.4	V
V_{AN}	Input voltage range	Analog inputs	0		3	V

Package Outline and Pin Configuration

Mounting (M3-size Threads):

M1: x = 4.0 mm, y = 86.0 mm

M2: x = 98.0 mm, y = 86.0 mm

M3: x = 4.0 mm, y = 4.0 mm

M4: x = 98.0 mm, y = 4.0 mm

Power Terminals: M4-size Screws

Pin Descriptions Platform Bus X3:

- | | |
|---|----------------------|
| 1: GND | for TYCO Plug 14-POL |
| 2: RES1 | 8-215083-4 |
| 3: RES2 | |
| 4: RES3 (Analog) | |
| 5: RES4 | |
| 6: RES5 | |
| 7: RES6 | |
| 8: PULSE | |
| 9: ENABLE | |
| 10: GND | |
| 11: RS485_A1 [120Ω Termination, DIP-Switch J1, 1] | |
| 12: RS485_B1 | |
| 13: RS485_A2 [120Ω Termination, DIP-Switch J1, 2] | |
| 14: RS485_B2 | |

LDD Board

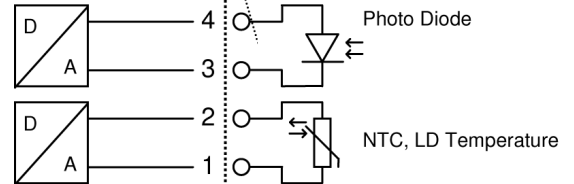

for TYCO 4-POL
Plug Housing
794617-4

with AWG 20-24
Crimp Contacts
794610-1

X8

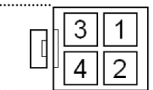

4-POL Connector,
Back View (Cable
Insertion Voids)

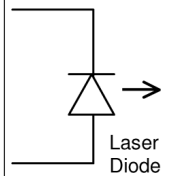

Laser Diode

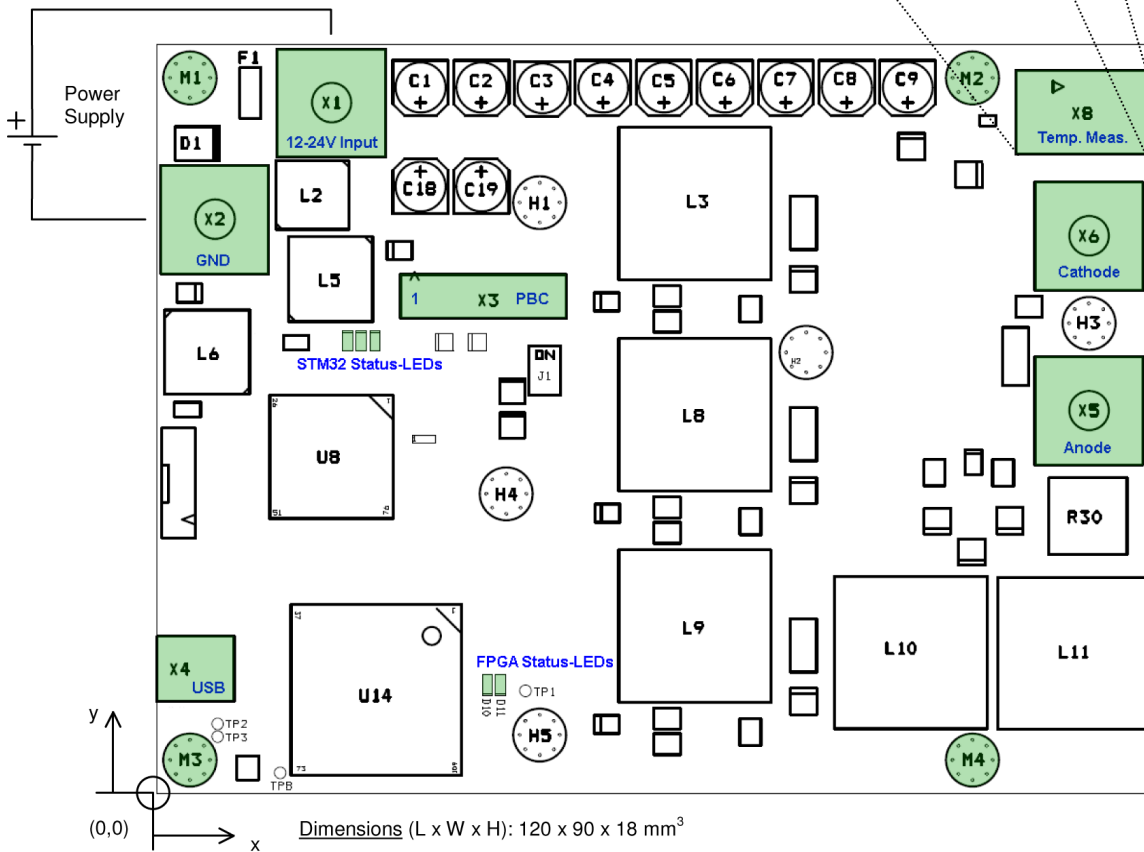

Laser diode, temperature probes, power supply and connectors not included.

Current-Controlled Operation-Modes and Communication Option

The LDD-1125 is an OEM high performance current source that is primarily designed to operate as a fast pulsed laser diode driver but that can also be used in CW mode. It is configured over an industry-standard RS485 or a USB connection, either GUI-driven using the included LDD Service Software, or by direct parameter control using the predefined communication protocol. Basic system status is visually indicated by on-board LEDs, more detailed status information can be polled at any time. The LDD-1125 can operate in a stand-alone configuration as well as in a remotely-controlled manner, with parameters adjusted on the fly. The laser diode driver is current-PID-controlled.

Configuration parameters further include: control source selection, maximum current limits, nominal current ramping, PID controller settings, NTC temperature sensor modeling coefficients, measurement circuitry calibration, error thresholds, communication watchdog, etc. Please refer to the user manual for further information.

Typical Current Waveforms

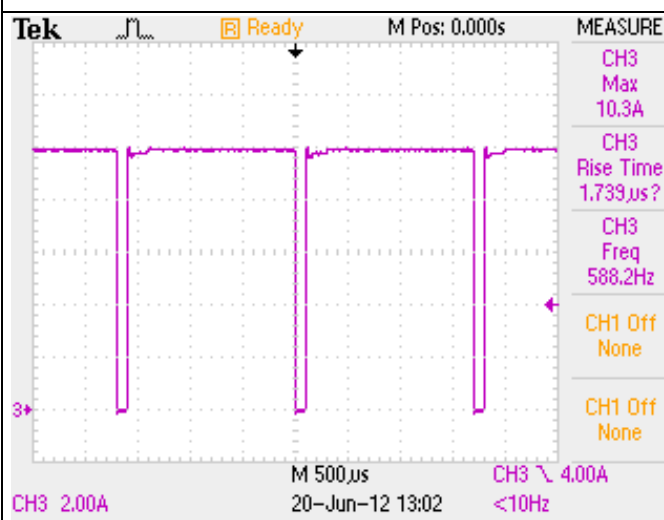

High duty-cycle chopping, unmodulated CW.

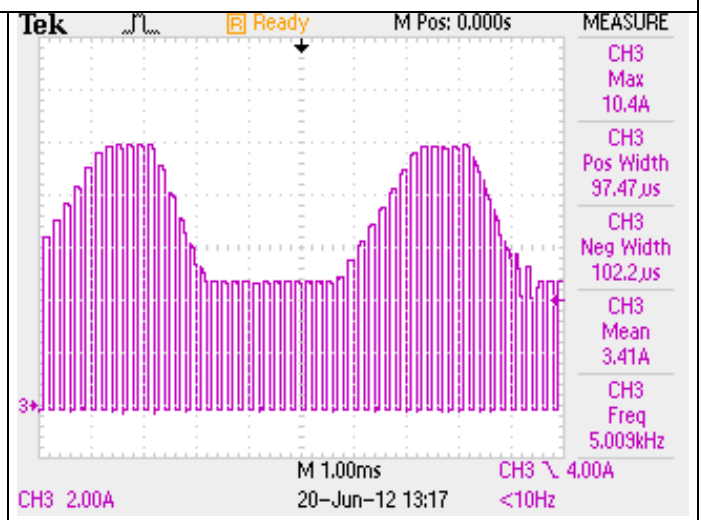

High repetition rate chopping, modulated CW.

LDD Service Software

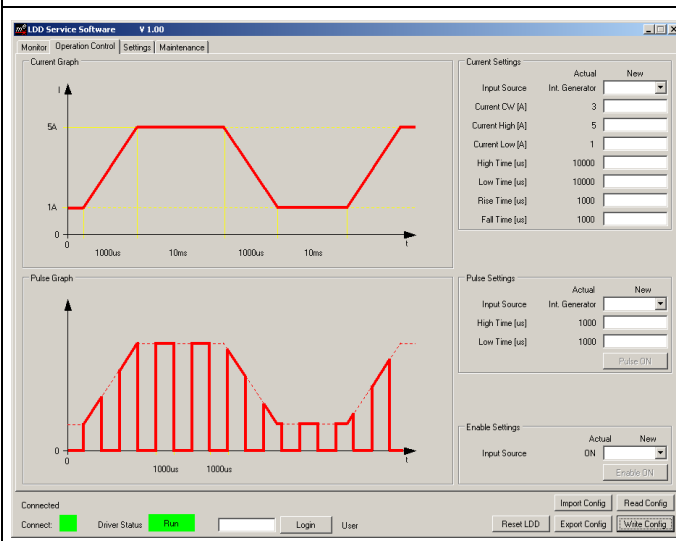

The included LDD Service Software is a powerful tool that allows monitoring and full configuration of the LDD-1125 via a standard USB or an RS485 connection from a PC running Windows XP or 7.

This tool is ideal for laboratory setups, product evaluation diagnosis, debugging and commissioning:

- internal generators set up [cf. illustration on the left]
- configuration import and export
- data charting with trigger functionality
- error codes and built-in descriptions
- hardware configuration (e.g. calibration)
- maintenance (e.g. firmware upgrades)

Please refer to the laser diode driver user manual for more information on features and system requirements.

CW Current Modulation and Chopping by Internal Generators.

Light-Controlled Operation-Mode [Devices with LPC Option only]

The LDD-1125-LPC is a laser power controller that is based on the LDD-1125, with additional light measurement circuitry (photodiode input). A user-defined 'Light System Scale' factor links the generated photocurrent to the absolute light power. The light PID controller's output is fed to the current controllers input. The nominal light power value may be CW, modulated CW (using internal generation) or remotely controlled. A configurable soft-start feature is available, as well.

Typical LPC Waveforms

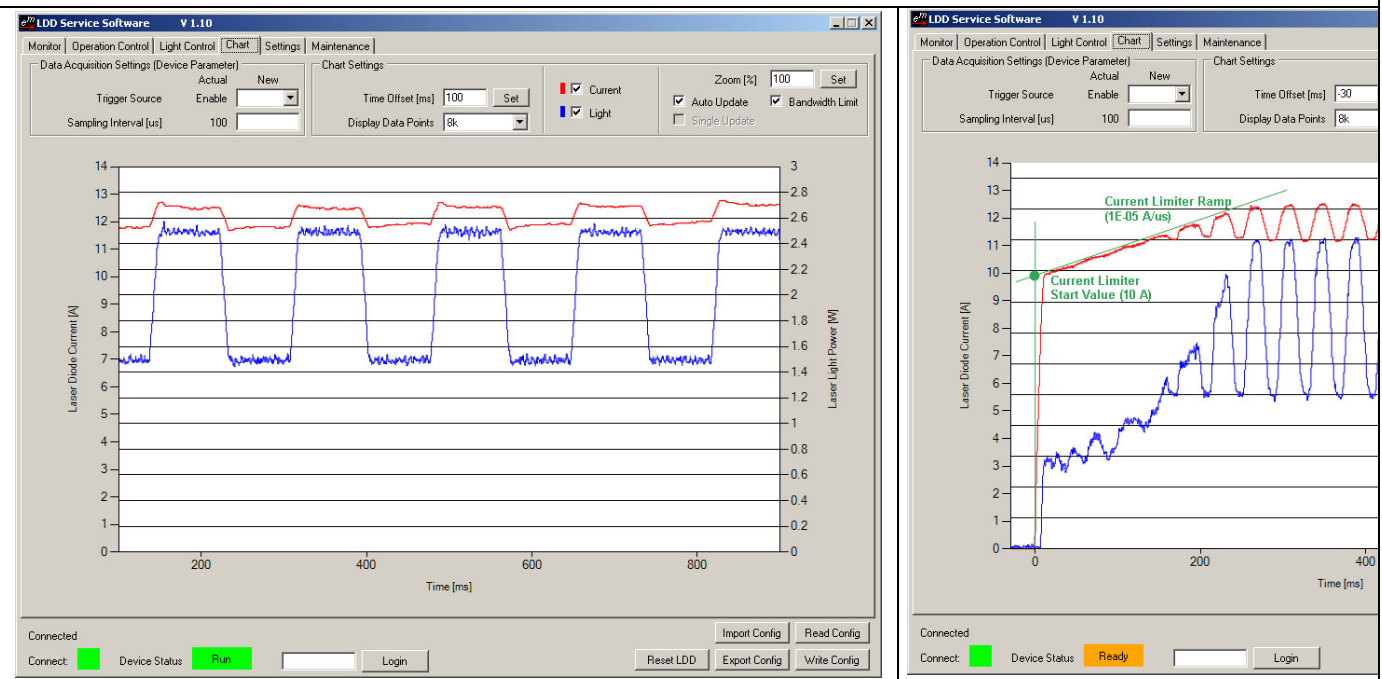

Laser Power Control (blue) and Diode Current (red).

LPC Soft-Start Limitation (green)

Light Measurement Characteristics [Devices with LPC Option only]

Unless otherwise noted: $T_A = 25\text{ }^\circ\text{C}$, $V_{IN} = 24\text{ V}$, $V_{BIAS} = -3.3\text{ V}$

Symbol	Parameter	Conditions	Min	Typ	Max	Units
Photodiode Input Characteristics:						
I_{PD}	Photodiode current		50		10'000	μA
$f_{\text{Transimpedance}}$	Cutoff frequency	$R_{46} = 2200\ \Omega$, $C_{106} = 47\text{ pF}$		1.6		MHz
f_{ADC}	Sampling frequency	@ 16bit		1		MHz
Laser Power Control Characteristics:						
-	Light System Scale	The range that can be user-entered.	0		1000	A/W

LDD-1125-LPC Hardware Configuration

Light Measurement Configuration, Photodiode-Dependent
Transimpedance Amplification and Selectable Bias Voltage

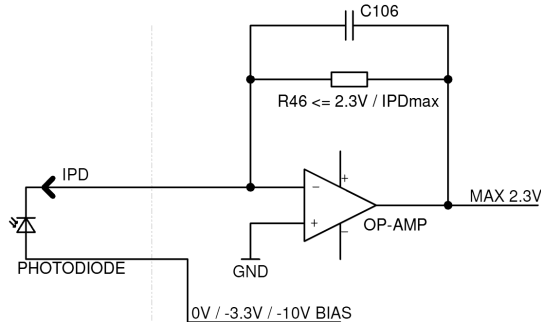

I_{PDmax} [μ A]	R_{46} [Ω]	Suffix [.]
≤ 10 mA	220	k22
≤ 5 mA	470	k47
≤ 2 mA	1000	1k0
≤ 1 mA	2200	2k2
≤ 500 μ A	4700	4k7
≤ 200 μ A	10000	10k
≤ 100 μ A	22000	22k
≤ 50 μ A	47000	47k

LDD-1125 Ordering Information

Part number*	LPC Option		Bias Voltage*		Max. Photodiode Current*	
	-Suffix	Signification	-Suffix	Signification	-Suffix	Signification
LDD-1125	[NA] -LPC	without LPC with LPC	-0 -1 -2	0 V -3.3 V -10 V	-xxx [see table above]	R_{46} in Ω [see table above]

*The suffixes Bias Voltage (for photoconductive mode) and Max. Photodiode Current (for optimal amplification) are only required if the LPC option is chosen

Example Configuration 1: LDD-1125

The above ordering information refers to an LDD-1125 0-30 A laser diode driver with current control

Example Configuration 2: LDD-1125-LPC-1-2k2

The above ordering information refers to an LDD-1125 with added Laser Power Control, -3.3 V bias voltage and a maximum photodiode current below 1 mA.

Further customization can include digital lines for control, and diagnosis and communication protocol. Please contact Meerstetter Engineering GmbH with your inquiry.

Meerstetter Engineering GmbH
Schulhausgasse 12
3113 Rubigen, Switzerland



Phone: +41 31 712 01 01
Email: contact@meerstetter.ch
Website: www.meerstetter.ch

Meerstetter Engineering GmbH (ME) reserves the right to make changes without further notice to the product described herein. Information furnished by ME is believed to be accurate and reliable. However typical parameters can vary depending on the application and actual performance may vary over time. All operating parameters must be validated by the customer under actual application conditions.