

### OEM TEC Controller



**RoHS**  
COMPLIANT

The TEC-1090 is a specialized TEC controller / power supply able to precision-drive a single Peltier element.

It features a true bipolar DC current source for cooling / heating, two temperature monitoring inputs (1x main, 1x auxiliary) and intelligent PID control with auto tuning. The TEC-1090 is fully digitally controlled, it's hard- and firmware offer numerous communication and safety options.

The included PC-Software allows configuration, control, monitoring and live diagnosis of the TEC controller via USB and RS485. All parameters are saved to non-volatile memory. Saving can be disabled for bus operation.

For the most straightforward applications, only a power supply, Peltier elements and two temperature sensors need to be connected to the TEC-1090. After power-up the unit will operate according to pre-configured values. (In stand-alone mode no control interface is needed.)

The TEC-1090 can handle either Pt100, Pt1000 or NTC temperature probes. For highest precision and stability applications a Pt100 / 4-wire input configuration is recommended. Analog measurement circuit is factory calibrated.

Auxiliary temperature input allow the connection of an NTC probe that is located on the heat sink of the Peltier element. This additional data is used to compensate for parasitic thermal conduction of Peltier element. Also, it allows the control of an external heat sink cooling fan.

The heating and cooling power is optimized by proprietary thermal management routines based on power balance models (for Peltier elements and resistive heaters).

Further functionality includes: Smooth temperature ramping, thermal stability indication and auto gain (NTC probes). The PC-Software allows data logging and configuration import/export.

Many features (hardware, software) of this OEM product are customizable upon request.

### Features

#### Output Stage:

- Output Current: 0 to  $\pm 16$  A, <1.5% Ripple (0 to  $\pm 10$  A available as TEC-1089)

#### -HV (High Voltage) Version (stock item, recommended):

- DC Input Voltage: 12 – 36 V nominal
- Output Voltage / Channel: 0 to  $\pm 30$  V (max.  $U_{IN} - 6$  V)

#### Main Features:

- Temperature Sensor Types: Pt100, Pt1000, NTC
- Temperature Precision / Stability: <0.01°C
- Performance-optimized PID for Thermal Power Control
- Configuration / Diagnosis over USB / RS485 PC Software
- Dimensions (L x W x H): 75 mm x 60 mm x 18 mm
- Efficiency: 92 % (@ 50% Load)
- Cooling over Base Plate
- Auxiliary Peltier Heat Sink NTC Temp. Sensor Input

#### Operation Modes:

- Stand-Alone without Live Control Interface
- Remotely-Controlled over USB, RS485, RS422, I/O
- Script-Controlled over Lookup Table Read-Out

#### Driver Modes:

- DC Power Supply: Set Current or Voltage
- Temperature Control: PID Settings, Auto Tuning, optional Cool/Heat-Only or Resistor modes

#### Data Interfaces:

- USB 2.0 1kV isolated (FTDI Chip)
- 2x RS485 / RS422

#### General Purpose I/O Features:

- 4x Digital I/O Signals (3.3 V / 5 V)
- Configurable as Input to control TEC-1090 (Enable, Temperature Up / Down etc.)
- Configurable as output to monitor TEC-1090 (Error Indication, Temperature Stable Indication etc.)

#### Optional Components:

- Display Unit: 2x16 Char OLED (DPY-1113)

#### Further Information:

- Please contact us for additional information, or consult the current TEC Controller User Manual (Document 5134).
- The TEC-1090 is part of the TEC-Family of Meerstetter TEC controllers. It is designed to operate alongside devices of the LDD-Family of laser diode drivers. Both families of drivers share the same system bus, design, technology and physical dimensions.

### Absolute Maximum Ratings

Supply voltage (DC)	37 V (-HV)
Supply current (DC)	20 A (On Board Fuse)

Bipolar output voltage	±35 V (-HV)
Bipolar output current	±22 A

### Operating Characteristics

Temperature	-40 – 85°C
Humidity	5 – 95%, non-condensing

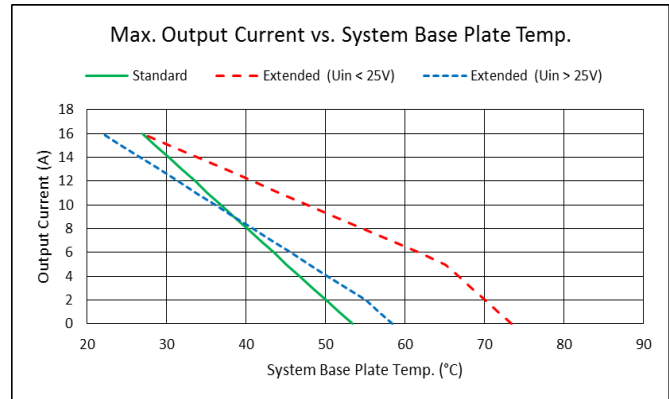
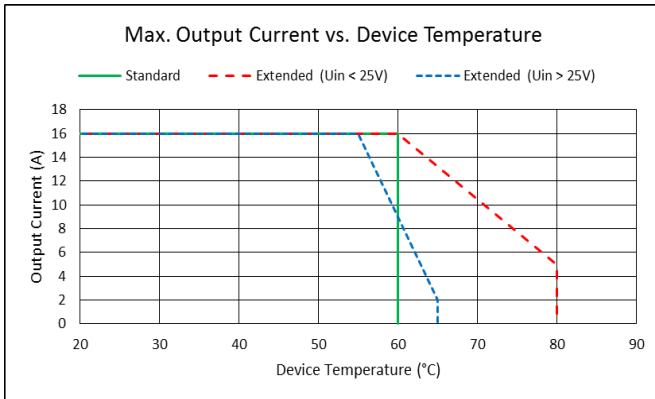

Test Condition: TEC Controller pressed with 1.2kPa to an aluminum System Base Plate without any thermal conductivity material in between. Using a good thermal conductivity material is recommended for high output currents. Standard or Extended Device Temperature Mode can be set as software setting.

### Electrical Characteristics for HV (High Voltage) Version

Unless otherwise noted: T<sub>A</sub> = 25°C, U<sub>IN</sub> = 36 V, R<sub>load</sub> = 2 Ω

Symbol	Parameter	Test Conditions	Min	Typ	Max	Units
<b>DC Power Supply Input:</b>						
U <sub>IN</sub>	Supply voltage	Measured directly on power input terminals	11.5	36	36.5	V
U <sub>IN</sub> Ripple	Ripple tolerance				300	mV <sub>PP</sub>
<b>Output (per Channel):</b>						
I <sub>OUT</sub>	Bipolar current swing				±16	A
U <sub>OUT</sub>	Bipolar voltage swing	U <sub>IN</sub> at least 6 V greater than U <sub>OUT</sub> Measured directly on power output terminals			±30	V
U <sub>OUT</sub> Ripple	Voltage ripple	R <sub>load</sub> = 1.75 Ω @ 16 A		200		mV <sub>PP</sub>
<b>System Characteristics:</b>						
η <sub>50%</sub>	Power efficiency	@ 50% load		92		%
η <sub>90%</sub>	Power efficiency	@ 90% load		94		%
<b>Output Monitoring</b> (I <sub>OUT</sub> Resolution is 12.2mA; U <sub>OUT</sub> Resolution is 10.25mV)						
I <sub>OUT</sub> Read	Precision	@ 15.5 A		1	5	%
U <sub>OUT</sub> Read	Precision	@ 30.0 V		1	3	%
<b>Input Reverse Polarity Protection:</b> (GND input is connected through a Power MOSFET which is not active when reverse polarity is applied to the power supply terminals.)						
U <sub>IN</sub> Pol.	Reverse polarity				-37	V

### Output Safety Characteristics

Unless otherwise noted: T<sub>A</sub> = 25°C, U<sub>IN</sub> = 24 V

Symbol	Parameter	Test Conditions	Min	Typ	Max	Units
<b>Output Stage Protection Delays:</b>						
t <sub>OFF</sub> Short circuit		Full load condition		10	30	μs
t <sub>OFF</sub> Power system limits		Current and voltage limits			200	μs
t <sub>OFF</sub> System failure		System status or temperature faults		100		ms
t <sub>IMMUN</sub> Immunity to transient noise		Duration of noise on temperature monitors	300			ms
<b>Output Stage Current Supervision:</b> (If the OUT+ and OUT- currents differ too much, an error is generated)						
I <sub>OUT_DIFF</sub>	Error threshold			800		mA

## Object Temperature Measuring Characteristics (Pt100 and Pt1000 Probes)

$T_A = 25^\circ\text{C}$ , measurement configuration = 23bit / 4-wire / unshielded cable <50mm

Symbol	Parameter	Test Conditions / Hints	Min	Typ	Max	Units
$T_{\text{OBJ, RANGE}}$	Range	Range is extendable upon request (Default measurement range is $-220^\circ\text{C} \dots +200^\circ\text{C}$ )	-50		+200	$^\circ\text{C}$
$T_{\text{OBJ, PREC}}$	Precision	Device temperature = $25^\circ\text{C}$ (EN 60751 / IEC 751)		0.005	0.01	$^\circ\text{C}$
$T_{\text{OBJ, COEFF}}$	Temp. Coefficient	Relative to device temperature			1.6m	$^\circ\text{C}/\text{K}$
$T_{\text{OBJ, NOISE}}$	Value Noise	Reference measurement fluctuations while output stage operating @70% load		0.003		$^\circ\text{C}$
$T_{\text{OBJ, REP}}$	Repeatability	Repeated measurements of reference resistors after up to 3 days		0.005		$^\circ\text{C}$

## Object Temperature Monitoring Configurations (NTC Probes)

NTC thermistor resistive input characteristics translate into temperature ranges valid for only one type of NTC probe. Below example is given in the case of an NTC B<sub>25/100</sub> 3988K R<sub>25</sub> 10k temperature sensor.

Symbol	Parameter	Test Conditions	Min	Typ	Max	Units
<b>Thermistor Input and Temperature Monitoring Ranges:</b>						
$R_{\text{NTC, calibrated}}$	Calibrated resistance range (PGA = 1)	High- $^\circ\text{T}$ Configuration ( $R_s=18\text{k}\Omega$ ) Corresponding temperature range	1080	84.7 to 12.2	17910	$\Omega$ $^\circ\text{C}$
		Mid- $^\circ\text{T}$ Configuration ( $R_s=39\text{k}\Omega$ ) Corresponding temperature range	2340	61.7 to -3.4	38805	$\Omega$ $^\circ\text{C}$
		Low- $^\circ\text{T}$ Configuration ( $R_s=56\text{k}\Omega$ ) Corresponding temperature range	3360	51.8 to -10.1	55720	$\Omega$ $^\circ\text{C}$
$R_{\text{NTC, extended}}$	Extended resistance range. Auto Gain (PGA = 1 or 8)	High- $^\circ\text{T}$ Configuration ( $R_s=18\text{k}\Omega$ ) Corresponding temperature range	135	164.0 to 12.2	17910	$\Omega$ $^\circ\text{C}$
		Mid- $^\circ\text{T}$ Configuration ( $R_s=39\text{k}\Omega$ ) Corresponding temperature range	293	130.9 to -3.4	38805	$\Omega$ $^\circ\text{C}$

## Sink Temperature Measuring Characteristics (NTC only)

$T_A = 25^\circ\text{C}$ , measurement configuration = 12bit / 2-wire / unshielded cable <50mm,  $^\circ\text{T}$  probe = NTC B<sub>25/100</sub> 3988K R<sub>25</sub> 10k

Symbol	Parameter	Test Conditions / Hints	Min	Typ	Max	Units
$R_{\text{SINK, RANGE}}$	Range	Corresponding temperature range	180	150 to -6.0	44600	$\Omega$ $^\circ\text{C}$

## General Purpose Digital I/O Characteristics (RES1 ... RES8)

Unless otherwise noted:  $T_A = 25^\circ\text{C}$ ,  $U_{\text{IN}} = 24\text{V}$

Symbol	Parameter	Comments	Min	Typ	Max	Units
<b>Input Characteristics:</b>						
$U_{\text{IH}}$	Logic high input threshold		2.31			V
$U_{\text{IL}}$	Logic low input threshold				0.99	V
$U_{\text{IMAX}}$	Maximum input voltage		-0.5		5.5	V
<b>Output Characteristics:</b> (Microprocessor)						
$U_{\text{OH}}$	Logic high output voltage	Output current 8mA	2.9	3.3		V
$U_{\text{OL}}$	Logic low output voltage	Input current 8mA		0	0.4	V
<b>ESD Protection:</b> (Between Processor and Connector)						
$V_{\text{PP}}$	ESD discharge	IEC61000-4-2			100	kV
$R_A$	Series resistance		170	200	230	$\Omega$

### Package Outline and Pin Configuration

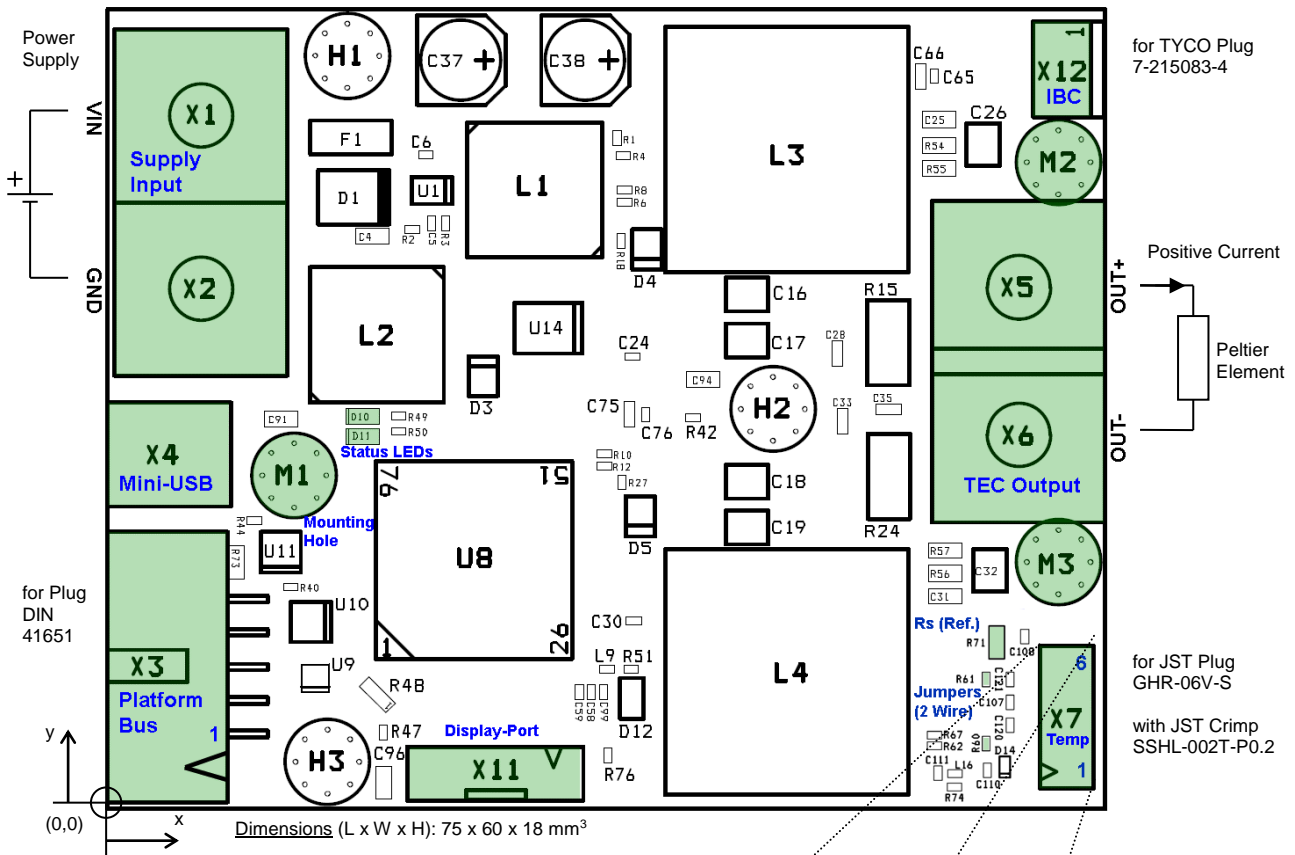

**Mounting** (3x 3.2mm Holes, 7.6 mm in Length):

- M1: x = 14.0 mm, y = 25.0 mm
- M2: x = 71.5 mm, y = 48.5 mm
- M3: x = 71.5 mm, y = 18.5 mm

**Power Terminals:** M4-size Screws

**Pin Descriptions** Platform Bus X3:

- 1: VIN Output (fused with polyfuse 100mA)
- 2: GND (fused with polyfuse 100mA)
- 3: RS485\_A1 [\*R72 = Termination (120Ω), N.A.]
- 4: RS485\_B1 (\*R72 not accessible from top)
- 5: RS485\_A2 [R73 = Termination (120Ω), N.A.]
- 6: RS485\_B2
- 7: RES1
- 8: RES2
- 9: RES3
- 10: RES4

**TEC Board X7**

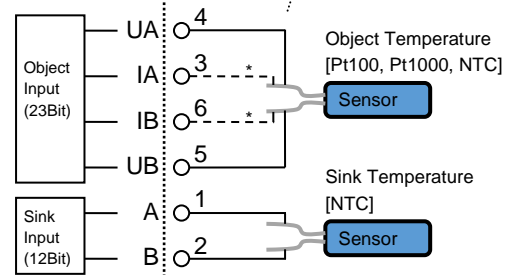

\* In case of Pt100 or Pt1000, use 4 wires to connect the Object Temperature Sensor

*Peltier element, temperature probes, power supply and connectors not included.*

## Operation-Modes and Communication Options

The TEC-1090 is an OEM precision TEC controller that is primarily designed to operate as a stand-alone device. Once configured and in operation, its basic status is visually indicated by on-board green and red LEDs and their blinking pattern. More detailed status information can be polled at any time by industry-standard RS485 connection or by USB (see box below). The TEC-1090 can also operate in a remotely-controlled manner, with parameters adjusted on the fly. The latest firmware upgrade introduced scripting capability by sequential lookup table read-out.

Configured as a DC power-supply, the TEC-1090 can handle current and voltage settings. In the remote-control case, temperature data may be passed on to be processed by the host.

Configurable parameters further include: sensor linearization (Pt100 / Pt1000) and Steinhart-Hart modeling (NTC), temperature acquisition hardware calibration, Peltier element modeling, PID controller auto tuning, nominal temperature ramping, current, voltage and temperature limits, error thresholds, etc. Please refer to the TEC Controller User Manual (Document 5134) for further information.

## TEC Service Software

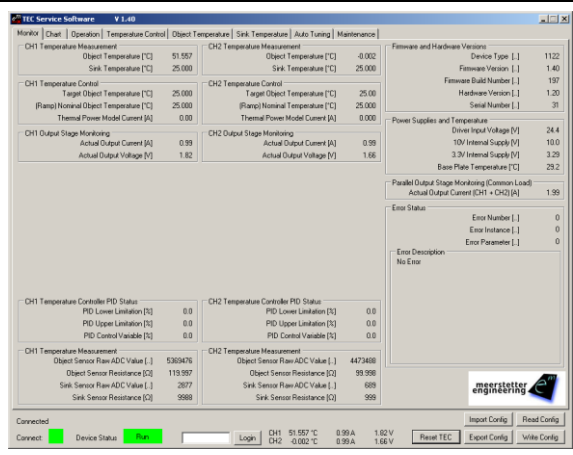

The included TEC Service Software is a powerful tool that allows monitoring, data logging and full configuration of the TEC-1090 via a standard USB or an RS485 connection from a PC running Windows.

This tool is ideal for laboratory setups, product evaluation and commissioning. In conjunction with the comprehensive set of error codes and built-in descriptions, it facilitates diagnosis and debugging.

The software also supplies a user-friendly interface for maintenance (e.g. firmware upgrades), device calibration and basic data logging.

Please refer to the user manual for more information on features and system requirements.

## Temperature Control (Autotuned PID)

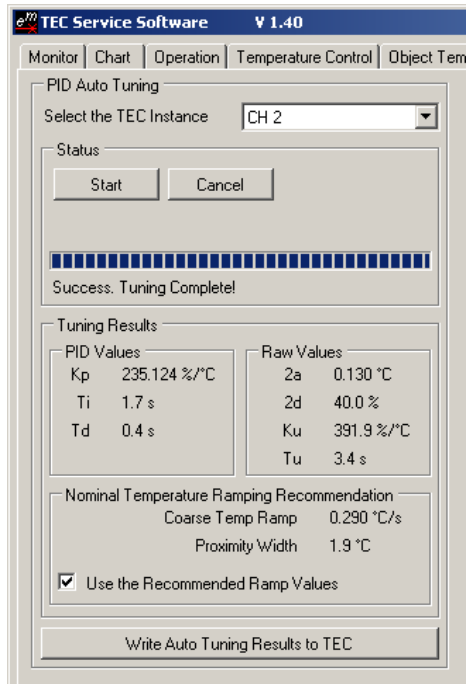
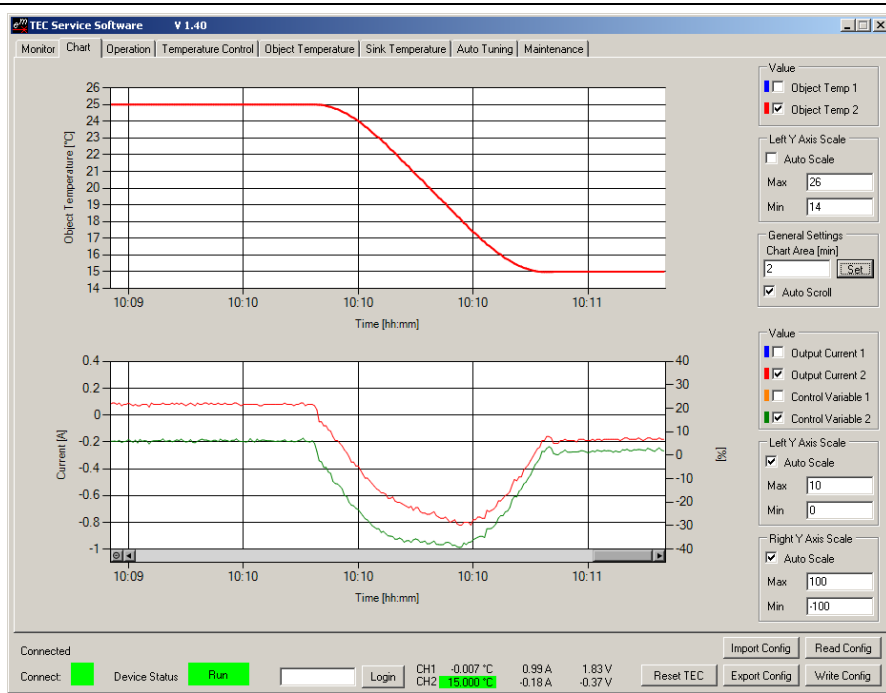

**TEC-1090 Ordering Information, Hardware Configuration**

Example Configuration: **TEC-1090-HV-PT100**

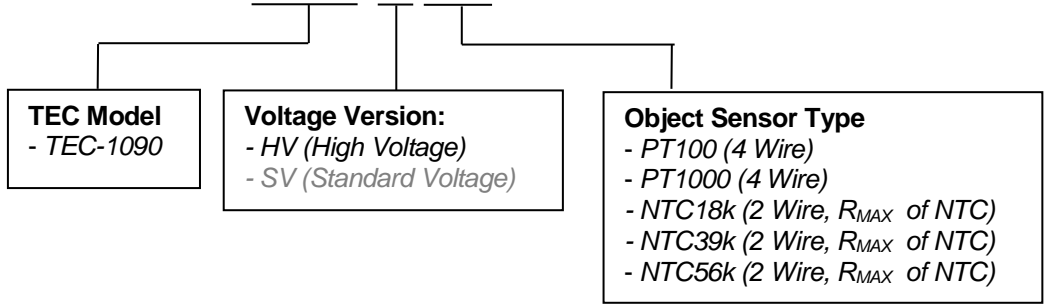

**Display Unit:**  
It is possible to connect an OLED 2x16 character display directly to the X4 connector. Please visit the DPY-1113 product web page for further information.

**Customization:**  
Many hardware and software features of the TEC-1090 are customizable upon request. Please contact Meerstetter Engineering with your enquiry.