

Advanced OEM Laser Diode Driver with Laser Power Control [LPC optional]



RoHS
COMPLIANT

The LDD-1125 is an innovative laser diode driver that contains a specialized current source able to precision-drive laser diodes in continuous / modulated and pulsed or mixed operation. Equipped with optional laser power measurement circuitry (photodiode input), the LDD-1125-LPC can also be operated as a Laser Power Controller.

Core element of the LDD's internal current source is the generation of highly precise 333 ps timing PWM steps that results in high resolution and very low ripple current.

The output is short-circuit safe and can be chopped for up to 40 kHz pulsed-mode operation. Driving low inductive loads, ultra short fall and rise times are achievable.

For ultimate laser diode protection the supervision of critical system values is directly implemented in hardware. This results in very fast switch-off times (<8 μ s) in case of limit value violation. The LDD-1125 also monitors laser diode temperature (NTC thermistor input).

The LDD-1125 is fully digitally controlled; its firmware is upgradeable to offer various communication options and to meet specific customer requirements.

Current, laser power [LPC option] and temperature measurement hardware can be calibrated.

For basic applications or device evaluation, only a power supply and a laser diode need to be connected to the LDD-1125. The device can operate stand-alone in current control mode, internal generators (on board) allow for parametric definition of flexible output waveforms.

The included PC-Software (USB / RS485) facilitates configuration, control, monitoring and live diagnosis of the LDD. Current and laser power [LPC option] charting is also available from within the software.

All device settings are saved in non-volatile memory and can be backed up and restored.

For remote / OEM applications, the LDD-1125 may be fully controlled by a system bus that features RS485 communication, pulse, interlock and 6 reserve lines.

The LDD-1125 is part of the LDD-Family of Meerstetter laser diode drivers, which are designed to operate alongside devices of the TEC-Family of Peltier controllers. Both families of drivers share the same system bus protocol, design concept and technology.

Features

-SV (Standard Voltage) Version:

- DC Input Voltage: 12-24 V
- Output Voltage: 0-15 V

-HV (High Voltage) Version:

- DC Input Voltage: 12-36 V
- Output Voltage: 0-27 V

Power Stage:

- Output Current: 0-30 A, <2% Ripple
Parallel operation on request
- Temperature Coefficient: Typ: 20 ppm/K
- CW Current Resolution: 0.6 mA
- Pulse Generation: CW Chopping
- Pulse Rise Time: 135 ns ($L_{Load} \sim 10$ nH)
- Pulse Frequency: up to 40 kHz

Laser Power Control (LPC): [LPC option]

- CW Laser Power Control: Configurable PID
- Start up phase: Fully parameterizable
- LPC Feedback. $PD_{Current}$: up to 4 mA

Main Features:

- Internal Generators: Nominal Current, Pulse
- Error: Ultra-Fast Switch-off for optimal LD protection
- Configuration / Diagnosis: on PC (via USB / RS485)
- Dimensions (L x W x H): 120 mm x 90 mm x 18 mm
- Efficiency: >94% (@ >50% Load)
- Cooling: over Base Plate

Interfaces

- USB 2.0 1kV isolated (FTDI Chip)
- 2x RS485 / RS422
- NTC for LD Temp.

Digital I/O, 3.3 V / 5 V

- Pulse Input
- Pulse Output (Trigger)
- Interlock (Enable)
- Generator Trigger Input

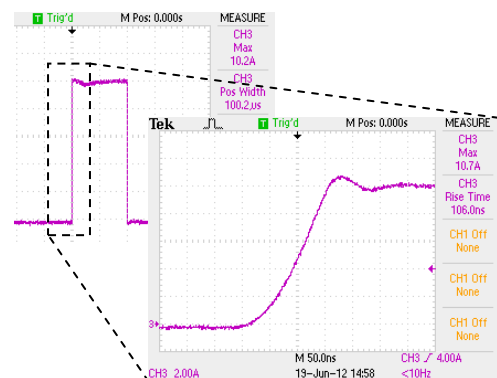

Absolute Maximum Ratings	
Supply voltage (DC)	27 V (HV: 37 V)
Supply current (DC)	25 A
Output current	35 A
Output voltage	V _{IN}

Operating Ratings	
System base plate	< 50 °C
Operation temperature	0 – 60 °C
Storage	-30 – 70 °C
Humidity	5 – 95%, non-condensing

Electrical Characteristics

Unless otherwise noted: T_A = 25 °C, V_{IN} = 24 V, V_{LD} = 10 V, LDD-1125-SV

Symbol	Parameter	Conditions	Min	Typ	Max	Units
DC Power Supply Input:						
V _{IN}	Supply voltage		11.5	24	26.5	V
V _{IN}	Supply voltage	LDD-1125-HV	11.5	36	36.5	V
V _{IN RIPPLE}	Ripple tolerance				300	mV _{PP}
System Characteristics:						
η _{50%}	Power efficiency	@ 50% load		95		%
η _{90%}	Power efficiency	@ 90% load		93		%

Output Characteristics

Unless otherwise noted: T_A = 25 °C, V_{IN} = 24 V, V_{LD} = 10 V, LDD-1125-SV

Symbol	Parameter	Conditions	Min	Typ	Max	Units
Output CW:						
I _{OUT}	Current range		0		30	A
T _{coefficient}	Temp. coefficient	I _{out} = 30A, T _A = 25 °C - 50 °C		20	35	ppm/K
I _{OUT RES}	Current resolution			0.6		mA
I _{OUT RIPPLE}	Current ripple	I _{out} > 2A		10	50	mA
V _{OUT MAX}	Diode voltage		0		15	V
V _{OUT MAX}	Diode voltage	LDD-1125-HV, V _{IN} = 36V	0		27	V
V _{OUT LIMIT}	Output voltage			V _{IN} - 8		V
P _{OUT}	Output power	V _{LD} = 15 V			450	W
f _{CW}	Current change	For L _{Load} < 100 nH, higher f _{CW} are possible		3		kHz
I _{OUT SLOPE}	Current slope limit	I _{out} > 10A		0.2		A/us
Output Pulse:						
t _{rise}	Current rise time	L _{Load} ~ 10 nH / V _{LD} = 2.5 V		135		ns
t _{fall}	Current fall time	L _{Load} ~ 10 nH / V _{LD} = 2.5 V		1200*		ns
t _{delay}	Delay pulse/current	L _{Load} ~ 10 nH / V _{LD} = 2.5 V		800		ns
t _{pH_min}	Minimal Pulse High	L _{Load} ~ 10 nH / V _{LD} = 2.5 V		1		us
t _{pL_min}	Minimal Pulse Low	L _{Load} ~ 10 nH / V _{LD} = 2.5 V		3		us

* Given by the discharge energy.

Safety Characteristics

Unless otherwise noted: T_A = 25 °C, V_{IN} = 24 V, V_{LD} = 10 V

Symbol	Parameter	Comments	Min	Typ	Max	Units
I/O Ports:						
t _{OFF_CURRENT}	Overcurrent			6	8	μs
t _{OFF_OPVAL}	Operating Values	Voltages, currents		100		μs
t _{OFF_SFAIL}	System failure	System status		100		ms

Laser Diode Temperature Measurement

Unless otherwise noted: T_A = 25 °C, V_{IN} = 24 V, NTC = B_{25/100} 3988K R₂₅ 10k

Symbol	Parameter	Comments	Min	Typ	Max	Units
Temperature Measurement						
R _{NTC}	NTC Resistance			10		kΩ
T _{RANGE}	Temperature Range		-6		150	°C
T _{PRECISION}	Temp. Precision	Not calibrated			1.5	°C

General Purpose Digital I/O Characteristics on X3 (RES1 ... RES8)

Unless otherwise noted: $T_A = 25^\circ\text{C}$, $V_{IN} = 24\text{ V}$

Symbol	Parameter	Comments	Min	Typ	Max	Units
Input Characteristics:						
V_{IH}	Logic high input threshold		2.35			V
V_{IL}	Logic low input threshold				0.9	V
V_{IMAX}	Maximum input voltage		-0.3		5.5	V
V_{AN}	Input voltage range	Analog input	0		3	V
Output Characteristics: (RES1 ... RES4)						
V_{OH}	Logic high output voltage		2.9	3.3		V
V_{OL}	Logic low output voltage			0	0.4	V
R_S	Series Resistor		170	200	230	Ω
Output Characteristics: (RES5 ... RES8)						
V_{OH}	Logic high output voltage		2.9	3.3		V
V_{OL}	Logic low output voltage			0	0.4	V
R_S	Series Resistor		1160	1200	1240	Ω
ESD Protection:						
V_{PP}	ESD discharge	IEC61000-4-2			100	kV

Light Measurement Characteristics [Devices with LPC Option only]

Unless otherwise noted: $T_A = 25^\circ\text{C}$, $V_{IN} = 24\text{ V}$, $V_{BIAS} = -3.3\text{ V}$

Symbol	Parameter	Comments	Min	Typ	Max	Units
Photodiode Input Characteristics:						
I_{PD}	Photodiode current				4	mA
f_{ADC_LPC}	Sampling frequency	@ 16bit		0.5		MSps

Operating Area (Pulse Mode)

Unless otherwise noted: $T_A = 25^\circ\text{C}$, $V_{IN} = 24\text{ V}$, $V_{LD} = 10\text{ V}$, LDD-1125-SV

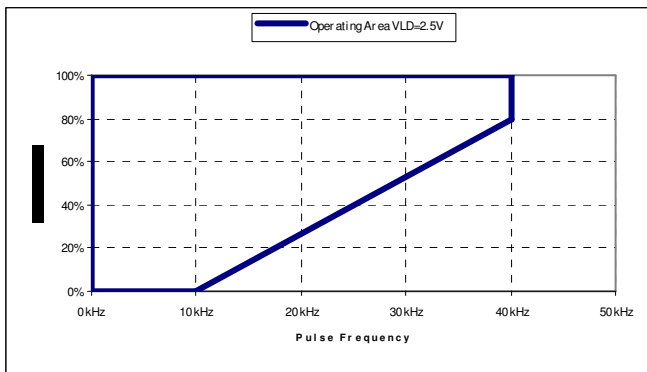

Test Conditions:

$T_A = 25^\circ\text{C}$, $V_{IN} = 24\text{ V}$, $I_{LD} = 20\text{ A}$
 $V_{LD} = 2.36\text{ V}@20\text{A}$, $R_{LD_Diff} = 68\text{ m}\Omega$, $L_{LD} = 10\text{ nH}$
 Laser diode directly mounted to the screw terminals.

The maximum achievable pulse frequency depends on the connected load's characteristics. The reason for the performance derating for high frequencies and low duty-cycles (bottom-right part of the operating area) are the internal control topology and available FPGA hardware resource.

Package Outline and Pin Configuration

Mounting (M3-size Bores, 7.5mm in Length):

M1: x = 4.0 mm, y = 86.0 mm

M2: x = 98.0 mm, y = 86.0 mm

M3: x = 4.0 mm, y = 4.0 mm

M4: x = 98.0 mm, y = 4.0 mm

Power Terminals: M4-size Screws

Pin Descriptions Platform Bus X3:

- 1: GND
 - 2: RES1
 - 3: RES2
 - 4: RES3
 - 5: RES4
 - 6: RES5
 - 7: RES6
 - 8: RES7
 - 9: RES8
 - 10: GND
 - 11: RS485_A1 [120Ω Termination, DIP-Switch J1, 1]
 - 12: RS485_B1
 - 13: RS485_A2 [120Ω Termination, DIP-Switch J1, 2]
 - 14: RS485_B2
- for TYCO Plug 14-POL
8-215083-4

LDD Board

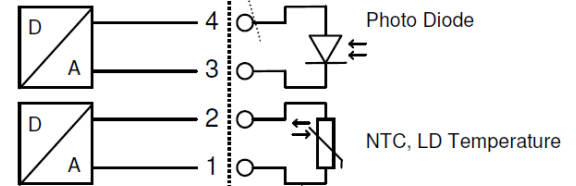

for TYCO 4-POL
Plug Housing
794617-4

with AWG 20-24
Crimp Contacts
794610-1

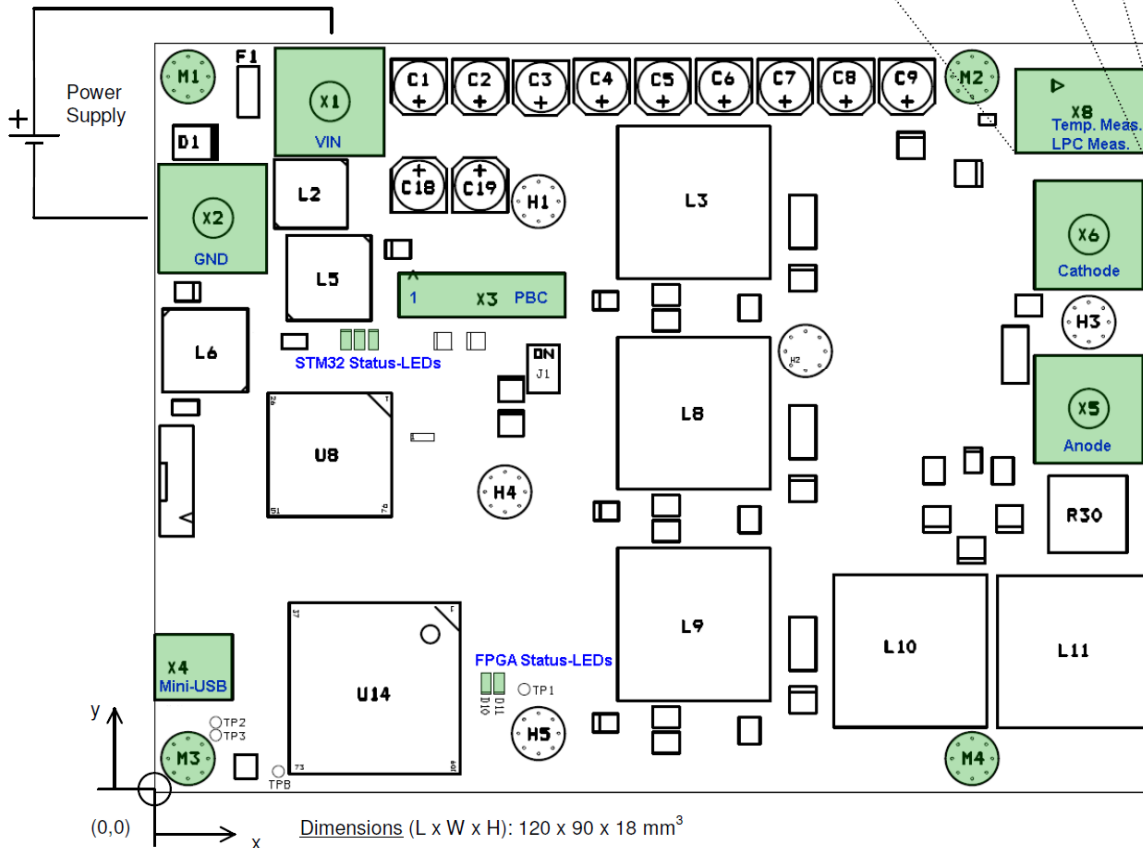
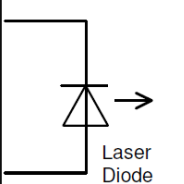
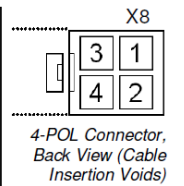

Dimensions (L x W x H): 120 x 90 x 18 mm³

Laser diode, temperature probes, power supply and connectors not included.

Current-Controlled Operation-Modes and Communication Option

The LDD-1125 is an OEM high performance current source that is primarily designed to operate as a fast pulsed laser diode driver but that can also be used in CW mode. It is configured over an industry-standard RS485 or a USB connection, either GUI-driven using the included LDD Service Software, or by direct parameter control using the predefined communication protocol. Basic system status is visually indicated by on-board LEDs, more detailed status information can be polled at any time. The LDD-1125 can operate in a stand-alone configuration as well as in a remotely-controlled manner, with parameters adjusted on the fly. The laser diode driver is current-PID-controlled.

Configuration parameters further include: control source selection, maximum current limits, nominal current ramping, PID controller settings, NTC temperature sensor modeling coefficients, measurement circuitry calibration, error thresholds, communication watchdog, etc. Please refer to the user manual for further information.

Typical Current Waveforms

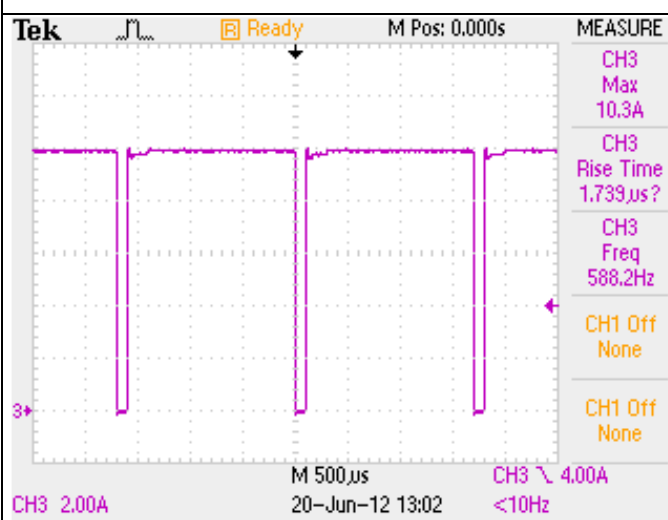

High duty-cycle chopping, unmodulated CW.

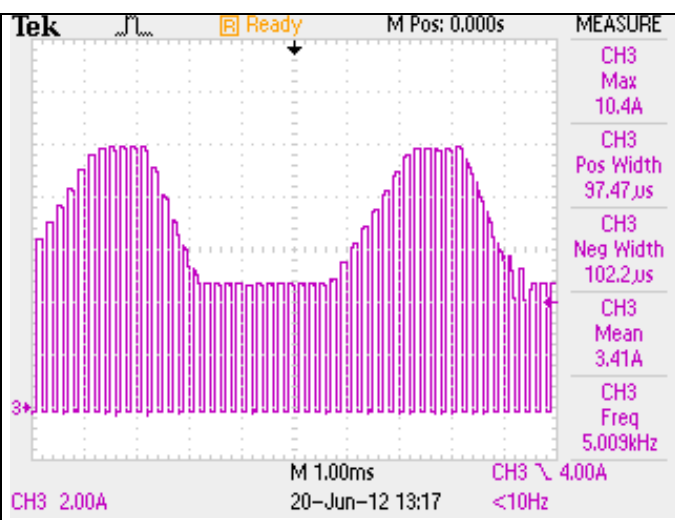

High repetition rate chopping, modulated CW.

LDD Service Software

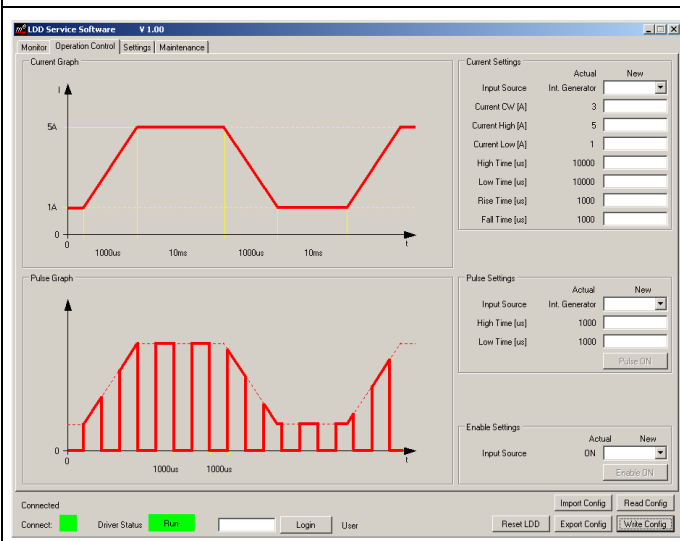

The included LDD Service Software is a powerful tool that allows monitoring and full configuration of the LDD-1125 via a standard USB or an RS485 connection from a PC running Windows.

This tool is ideal for laboratory setups, product evaluation diagnosis, debugging and commissioning:

- internal generators set up [see. illustration on the left]
- configuration import and export
- data charting with trigger functionality
- error codes and built-in descriptions
- hardware configuration (e.g. calibration)
- maintenance (e.g. firmware upgrades)

Please refer to the laser diode driver user manual for more information on features and system requirements.

CW Current Modulation and Chopping by Internal Generators.

Laser Power -Controlled Operation-Mode [Devices with LPC Option only]

The LDD-1125-LPC is a laser power controller that is based on the LDD-1125, with additional light measurement circuitry (photodiode input). A user-defined 'Light System Scale' factor links the generated photocurrent to the absolute light power. The light PID controller's output is fed to the current controllers input. The nominal light power value may be CW, modulated CW (using internal generation) or remotely controlled. A configurable soft-start feature is available, as well.

Typical LPC Waveforms

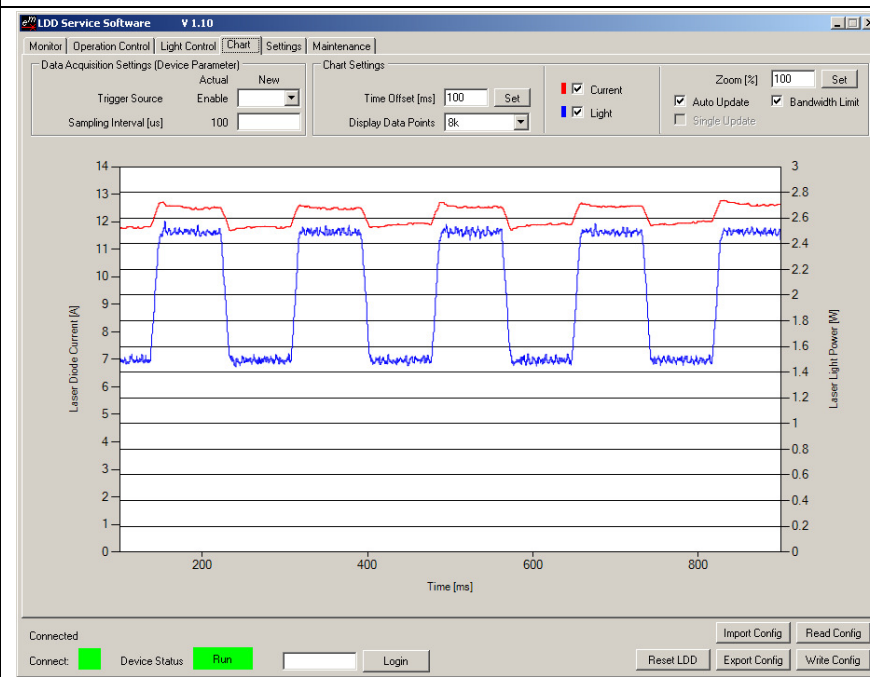

Laser Power Control (blue) and Diode Current (red).

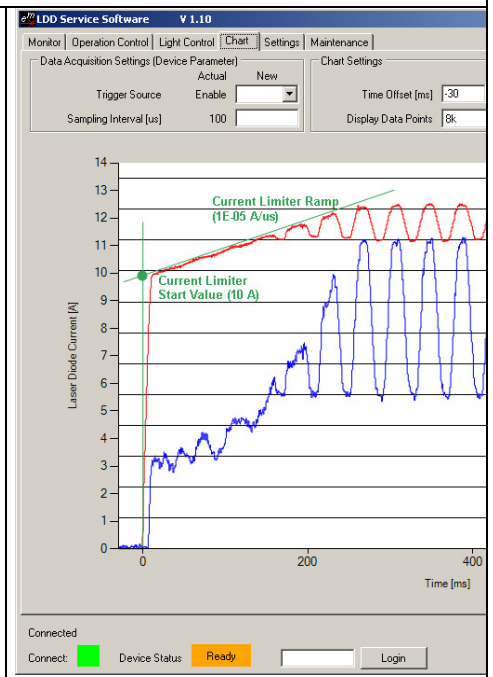

LPC Soft-Start Limitation (green)

LDD-1125 Ordering Information, Hardware Configuration

Example Configuration: **LDD-1125-SV[-Options]**

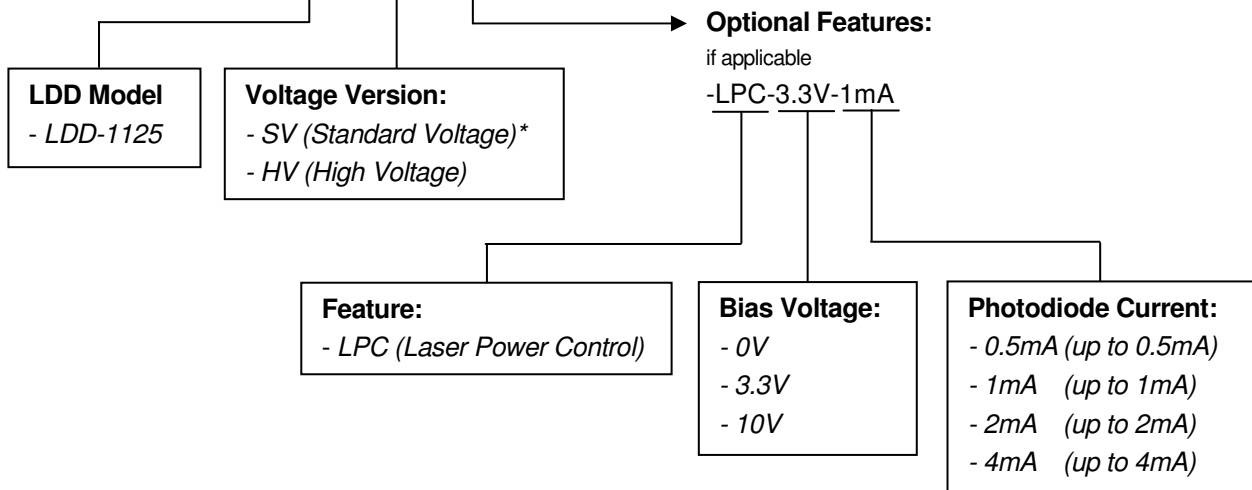

* Standard Version (Stock Item)

Further customization can include digital lines for control, and diagnosis and communication protocol. Please contact Meerstetter Engineering GmbH with your inquiry.

Meerstetter Engineering GmbH
Schulhausgasse 12
3113 Rubigen, Switzerland



Phone: +41 31 712 01 01
Email: contact@meerstetter.ch
Website: www.meerstetter.ch

Meerstetter Engineering GmbH (ME) reserves the right to make changes without further notice to the product described herein. Information furnished by ME is believed to be accurate and reliable. However typical parameters can vary depending on the application and actual performance may vary over time. All operating parameters must be validated by the customer under actual application conditions.